

修订 REV	标记 MARK	修改摘要 REVISION DESCRIPTION	签名 SIGNATURE	日期 DATE
AO		NEW RELEASE	WANG	2012-12-10

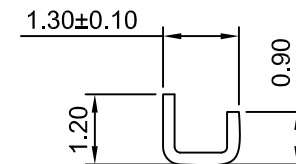

SEC:A-A

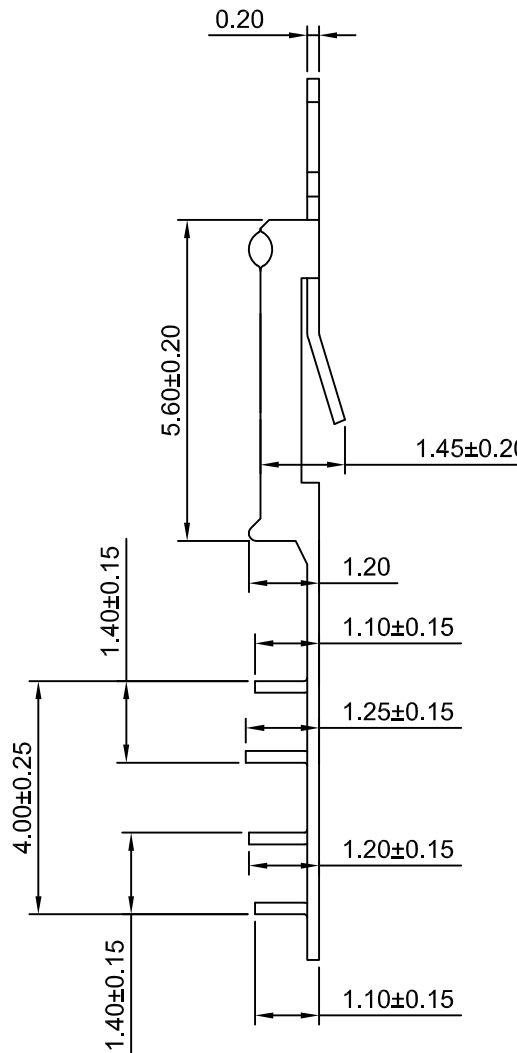
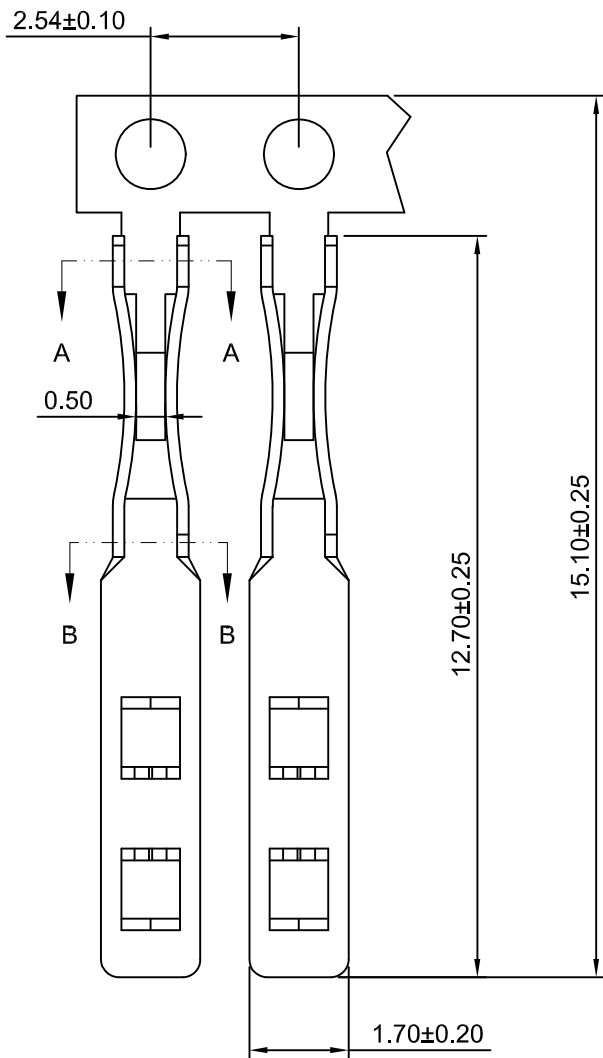
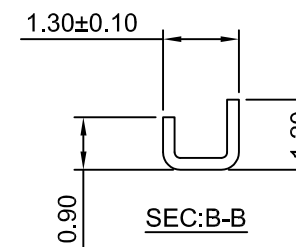

SEC:B-B

Ordering information & Specifications

Unit:mm

Part No	Wire Range	Insultion O.D.	Material	Finish	Qty/reel
HDGC2550-TP	FFC WIRE	——	Phosphor Bronze	Tin over Nickel	20,000 PCS
HDGC2550-GP	FFC WIRE	——	Phosphor Bronze	Gold over Nickel	20,000 PCS

Optional Gold plating available but MOQ requested



深圳市华德共创科技有限公司

SHENZHEN HUADE CO-CREATE TECHNOLOGY CO.,LTD

TEL : 0755-27129737 FAX : 0755-29940187

-TOLERANCES- UNLESS OTHERWISE SPECIFIED 公差参数表						TITLE: 产品名称: 2.54mm Pitch Crimp Terminal			
X.X	±0.30	X.X°	±3°	APPD: 核准:	XIE	PART NO: 产品编号: HDGC2550-T			
X.XX	±0.30	X.XX°	±2°	CHECK: 校对:	WANG	DATE	SCALE	UNIT	CODE NUMBER
X.XXX	±0.10	X.XXX°	±1°	DRAW: 绘图:	WANG	2012-12-10	8:1	mm	A008

修订 REV	标记 MARK	修改摘要 REVISION DESCRIPTION	签名 SIGNATURE	日期 DATE
AO		NEW RELEASE	WANG	2012-12-10

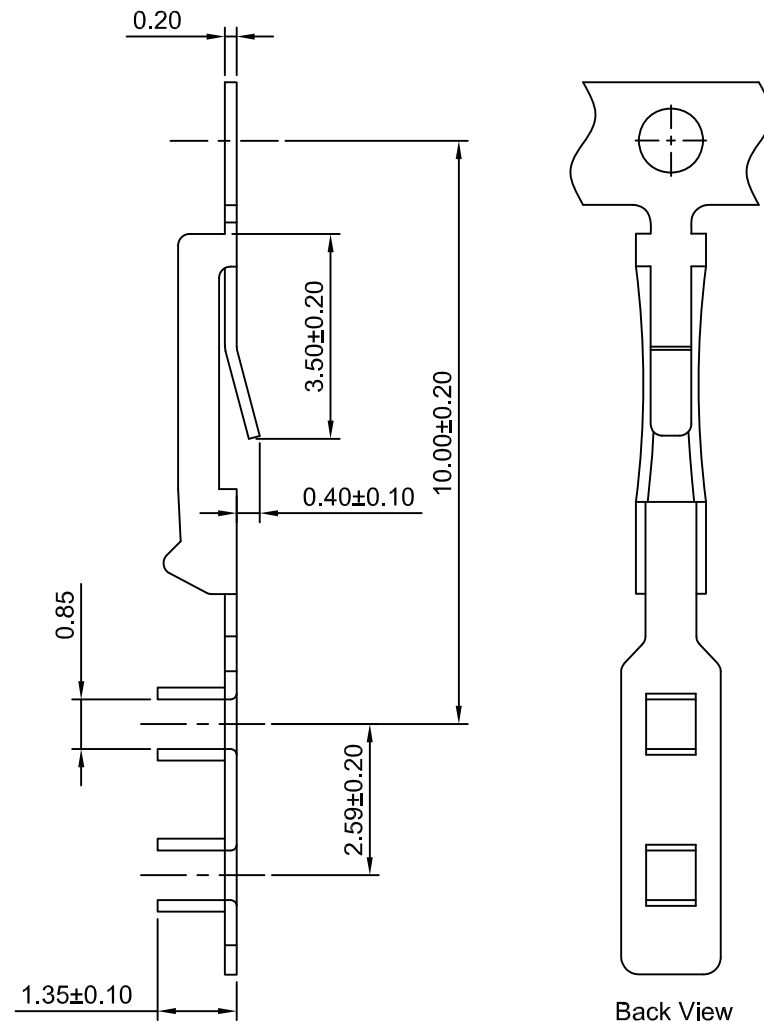
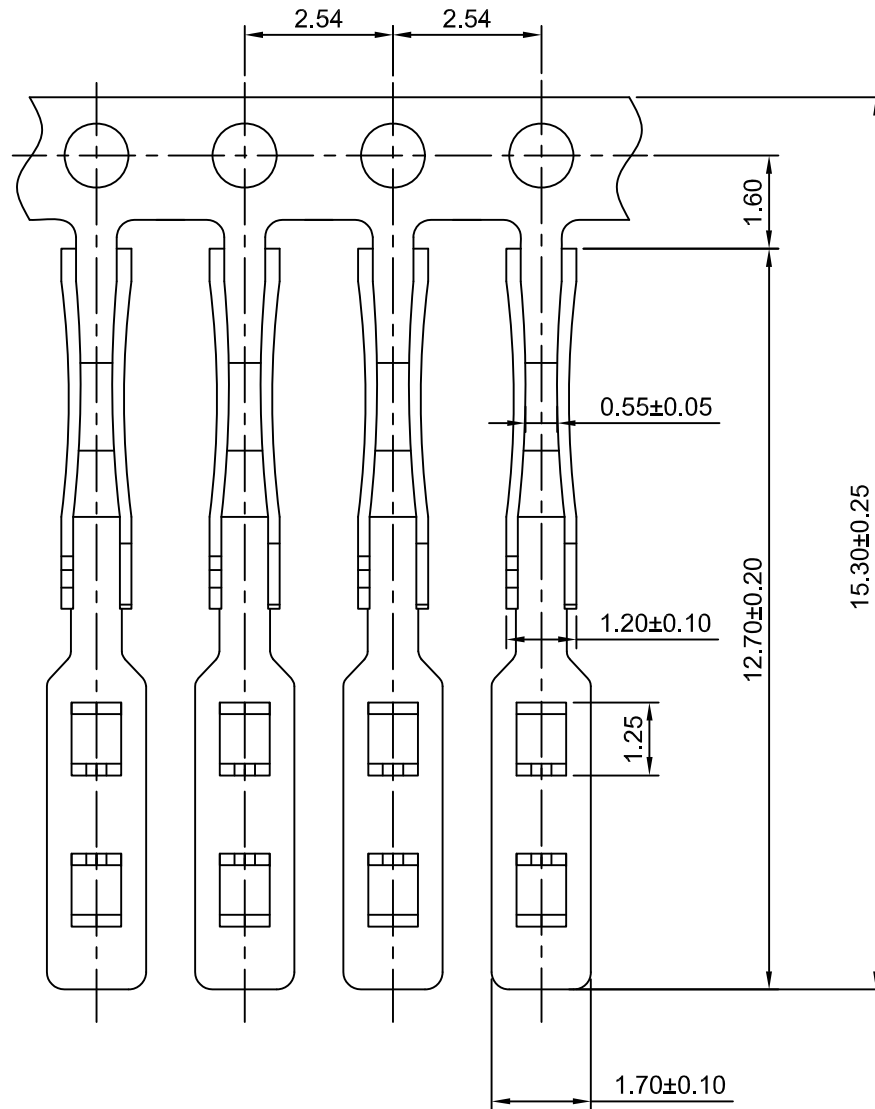

Ordering information & Specifications

Unit:mm

Part No	Wire Range	Insulation O.D.	Material	Finish	Qty/reel
HDGC2550-TP-CR	FFC WIRE	-----	Phosphor Bronze	Tin over Nickel	20,000 PCS

Optional Gold plating available but MOQ requested

深圳市华德共创科技有限公司
 SHENZHEN HUADE CO-CREATE TECHNOLOGY CO.,LTD
 TEL : 0755-27129737 FAX : 0755-29940187

-TOLERANCES- UNLESS OTHERWISE SPECIFIED 公差参数表					TITLE: 2.54mm Pitch 产品名称: Crimp Terminal			
X.X	±0.30	X.X°	±3°	APPD: 核准:	XIE			
X.XX	±0.30	X.XX°	±2°	CHECK: 校对:	WANG			
X.XXX	±0.10	X.XXX°	±1°	DRAW: 绘图:	WANG			
PART NO: 产品编号:					HDGC2550-T-CR			
DATE					SCALE	UNIT	CODE NUMBER	
2012-12-10					8:1	mm	A008	

修订 REV	标记 MARK	修改摘要 REVISION DESCRIPTION	签名 SIGNATURE	日期 DATE
AO		NEW RELEASE	WANG	2012-12-10

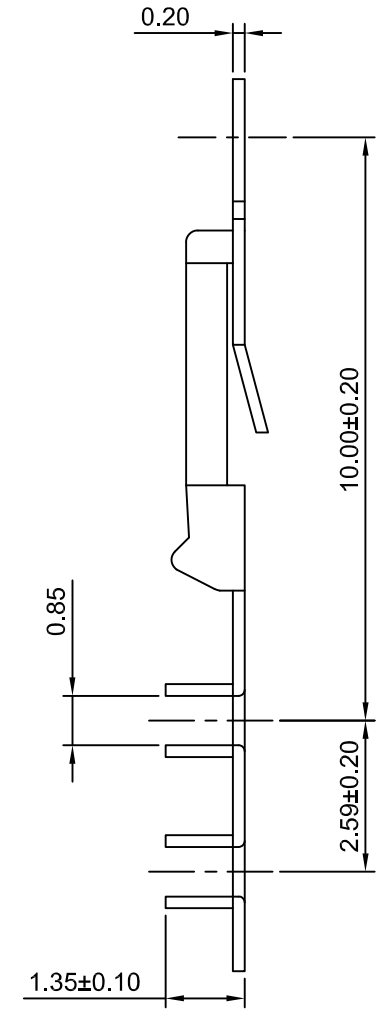
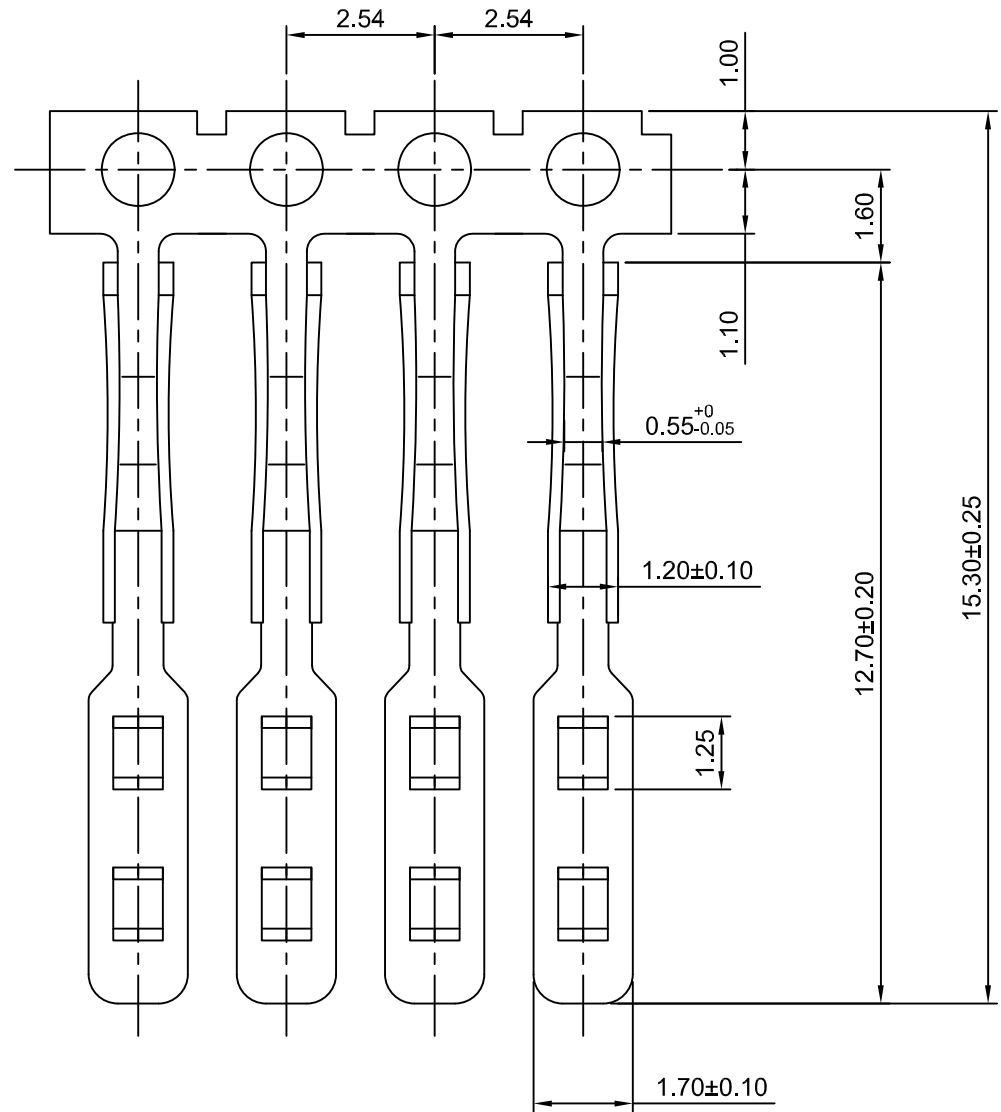

Ordering information & Specifications

Part No	Wire Range	Insulation O.D.	Material	Finish	Qty/reel
HDGC2550-TP-H-CR	FFC WIRE	-----	Phosphor Bronze	Tin over Nickel	20,000 PCS
HDGC2550-GP-H-CR	FFC WIRE	-----	Phosphor Bronze	Gold over Nickel	20,000 PCS

Optional Gold plating available but MOQ requested



深圳市华德共创科技有限公司
 SHENZHEN HUADE CO-CREATE TECHNOLOGY CO.,LTD
 TEL : 0755-27129737 FAX : 0755-29940187

-TOLERANCES- UNLESS OTHERWISE SPECIFIED 公差参数表				 		TITLE: 2.54mm Pitch 产品名称: Crimp Terminal			
X.X	±0.30	X.X°	±3°	APPD: 核准:	XIE	PART NO: 产品编号: HDGC2550-T-H-CR			
X.XX	±0.30	X.XX°	±2°	CHECK: 校对:	WANG	DATE	SCALE	UNIT	CODE NUMBER
X.XXX	±0.10	X.XXX°	±1°	DRAW: 绘图:	WANG	2012-12-10	8:1	mm	A008

修订 REV	标记 MARK	修改摘要 REVISION DESCRIPTION	签名 SIGNATURE	日期 DATE
AO		NEW RELEASE	WANG	2012-12-10

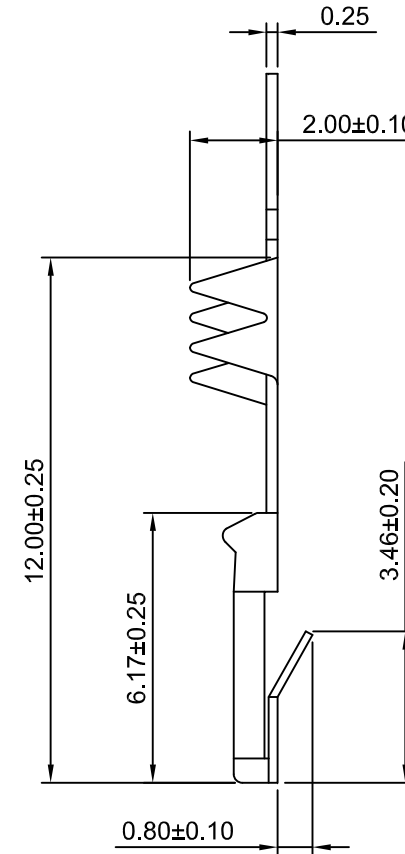
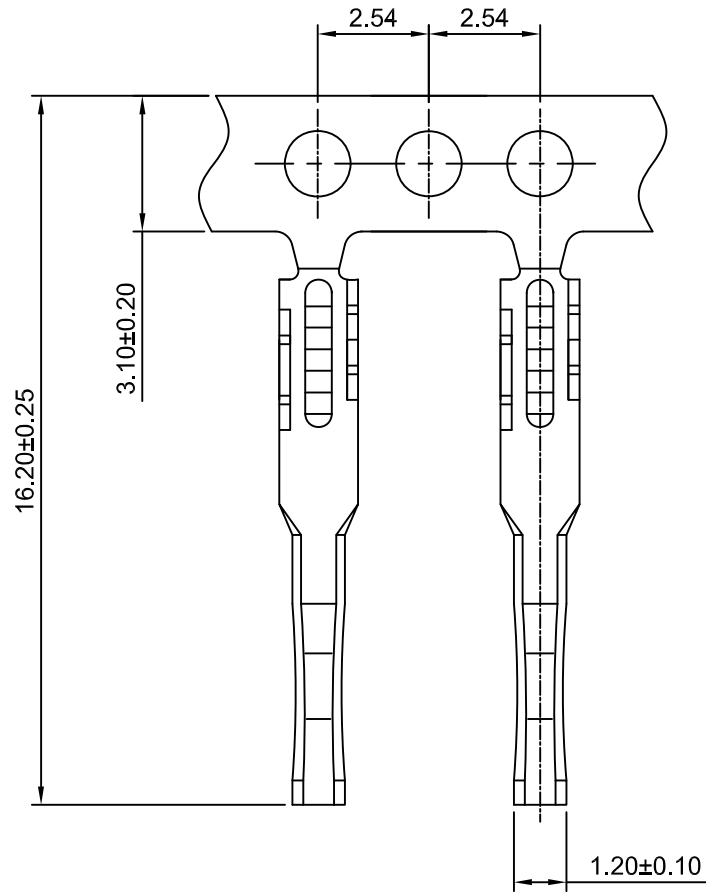

Ordering information & Specifications

Unit:mm

Part No	Wire Range	Insulation O.D.	Material	Finish	Qty/reel
HDGC2550-TP-A	FFC WIRE	----	Phosphor Bronze	Tin over Nickel	15,000 PCS
HDGC2550-GP-A	FFC WIRE	----	Phosphor Bronze	Gold over Nickel	15,000 PCS

Optional Gold plating available but MOQ requested



深圳市华德共创科技有限公司

SHENZHEN HUADE CO-CREATE TECHNOLOGY CO.,LTD

TEL : 0755-27129737 FAX : 0755-29940187

-TOLERANCES- UNLESS OTHERWISE SPECIFIED 公差参数表					TITLE: 2.54mm Pitch 产品名称: Crimp Terminal			
X.X	±0.30	X.X°	±3°	APPD: 核准:	XIE			
X.XX	±0.30	X.XX°	±2°	CHECK: 校对:	WANG	DATE	SCALE	UNIT
X.XXX	±0.10	X.XXX°	±1°	DRAW: 绘图:	WANG	2012-12-10	6:1	mm
PART NO: 产品编号:					HDGC2550-T-A			
CODE NUMBER					A008			

修订 REV	标记 MARK	修改摘要 REVISION DESCRIPTION	签名 SIGNATURE	日期 DATE
AO		NEW RELEASE	WANG	2018-09-10

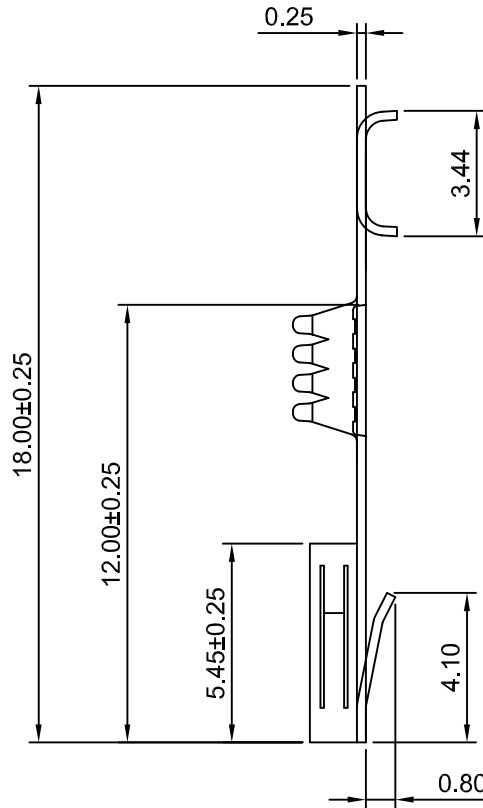
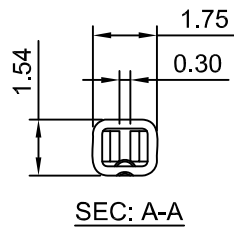
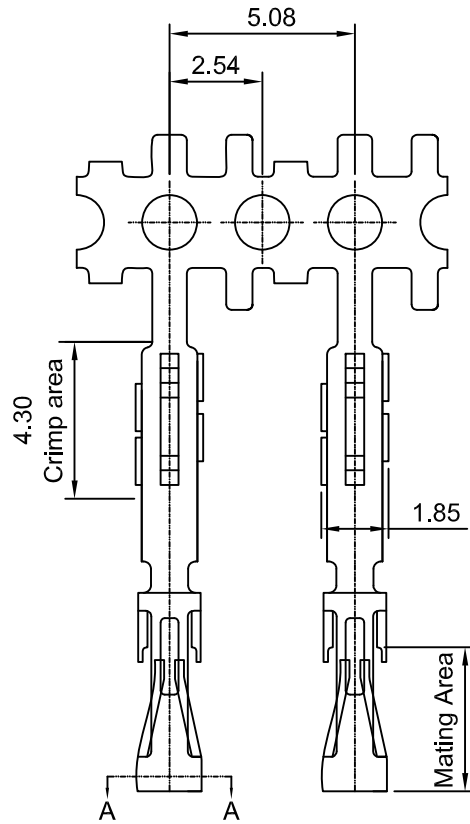

Ordering Information:

HDGC2550-GP-J - ***

1 2

1.Part No.

2.Finish

- TG :Mating Area : 100µin (2.54µm) MIN. Tin
Crimp Area: 1µin (0.025µm) MIN. Gold
- GT15 :Mating Area :15µin (0.38µm) MIN. Gold
Crimp Area: 100µin (2.54µm) MIN. Tin
- GT30 :Mating Area :30µin (0.76µm) MIN. Gold
Crimp Area: 100µin (2.54µm) MIN. Tin
- GT50 :Mating Area :50µin (1.27µm) MIN. Gold
Crimp Area: 100µin (2.54µm) MIN. Tin
- GG15 :Mating Area :15µin (0.38µm) MIN. Gold
Crimp Area: 1µin (0.025µm) MIN. Gold
- GG30 :Mating Area :30µin (0.76µm) MIN. Gold
Crimp Area: 1µin (0.025µm) MIN. Gold
- GG50 :Mating Area :50µin (1.27µm) MIN. Gold
Crimp Area: 1µin (0.025µm) MIN. Gold

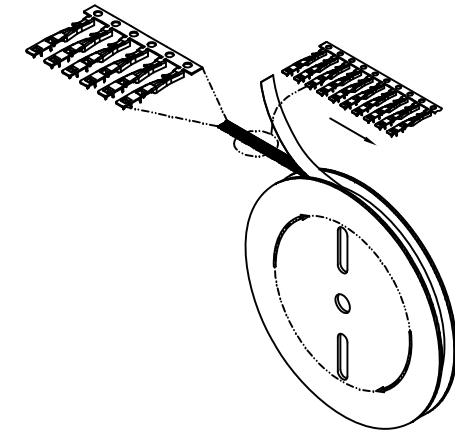

Winding Direction

Ordering information & Specifications

Unit:mm

Part No	Wire Range	Insultion O.D.	Material	Finish	Qty/reel
HDGC2550-TP-J	FFC WIRE	-----	Phosphor Bronze	Tin over Nickel	10,000 PCS
HDGC2550-GP-J	FFC WIRE	-----	Phosphor Bronze	Gold over Nickel	10,000 PCS

Optional Gold plating available but MOQ requested



深圳市华德共创科技有限公司

SHENZHEN HUADE CO-CREATE TECHNOLOGY CO.,LTD

TEL : 0755-27129737 FAX : 0755-29940187

-TOLERANCES- UNLESS OTHERWISE SPECIFIED 公差参数表				TITLE: 产品名称 : 2.54mm Pitch Crimp Terminal	
X.X	±0.30	X.X°	±3°	APPD: 核准 : XIE	PART NO: 产品编号 : HDGC2550-T-J
X.XX	±0.30	X.XX°	±2°	CHECK: 校对 : WANG	DATE
X.XXX	±0.10	X.XXX°	±1°	DRAW: 绘图 : WANG	SCALE
					UNIT
					CODE NUMBER
					A008

修订 REV	标记 MARK	修改摘要 REVISION DESCRIPTION	签名 SIGNATURE	日期 DATE
AO		NEW RELEASE	WANG	2012-12-10

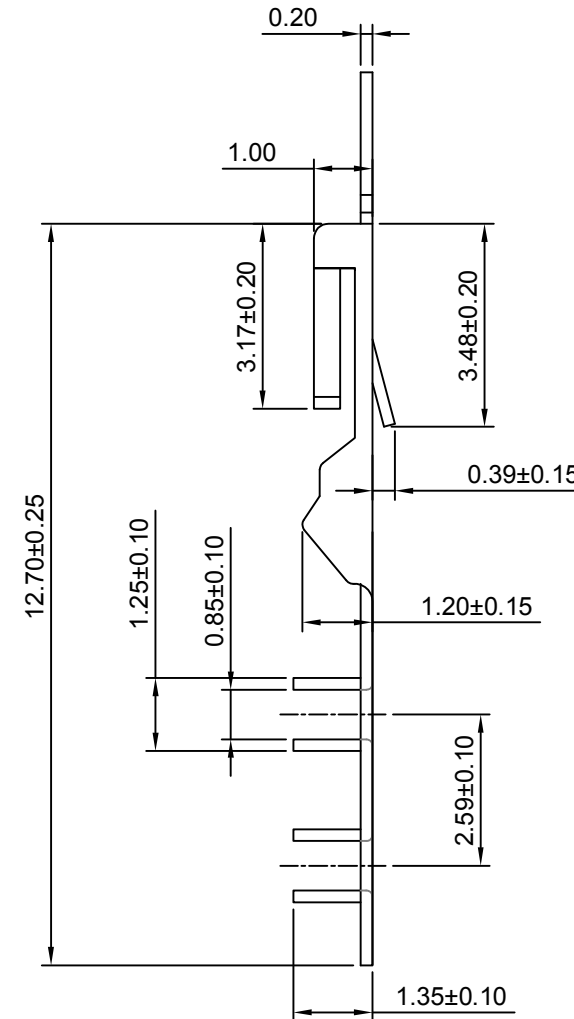
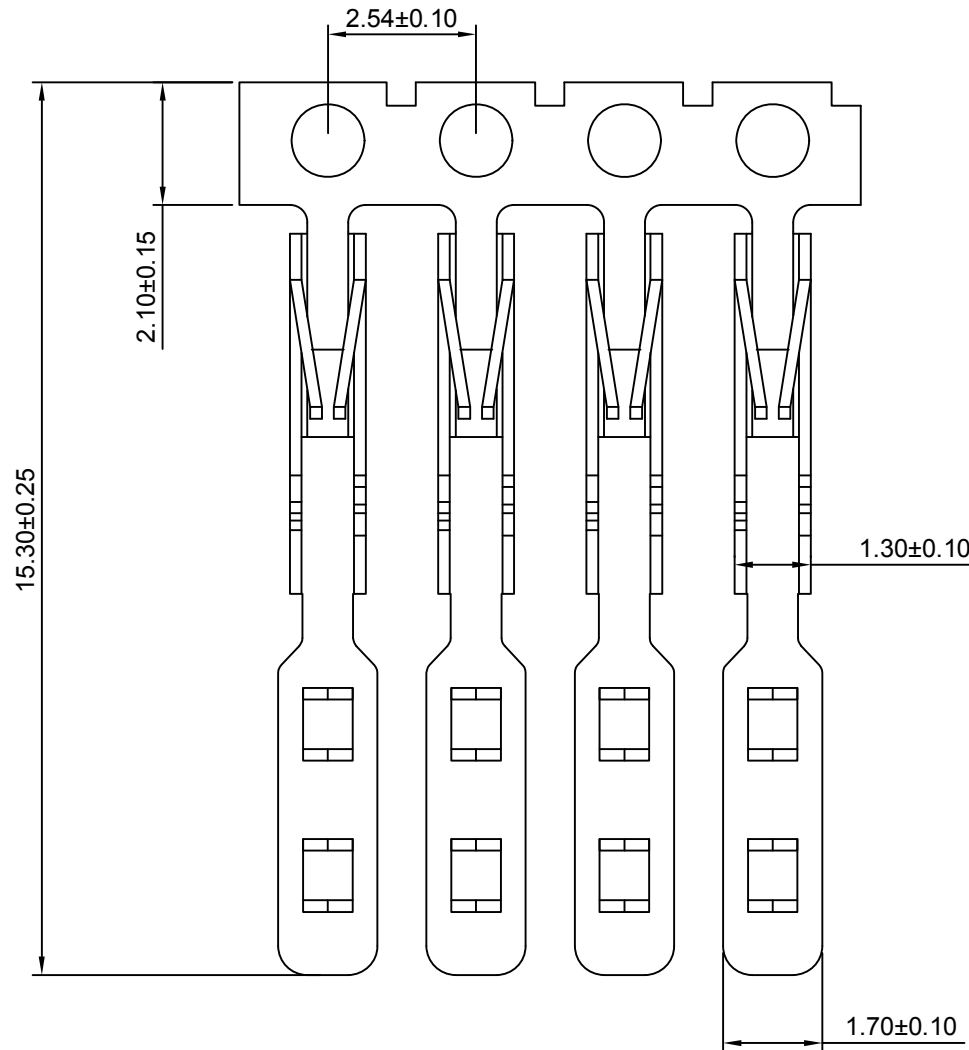

Ordering information & Specifications

Unit:mm

Part No	Wire Range	Insultion O.D.	Material	Finish	Qty/reel
HDGC2550-TP-C	FFC WIRE	-----	Phosphor Bronze	Tin over Nickel	20,000 PCS
HDGC2550-GP-C	FFC WIRE	-----	Phosphor Bronze	Gold over Nickel	20,000 PCS

Optional Gold plating available but MOQ requested



深圳市华德共创科技有限公司

SHENZHEN HUADE CO-CREATE TECHNOLOGY CO.,LTD

TEL : 0755-27129737 FAX : 0755-29940187

-TOLERANCES- UNLESS OTHERWISE SPECIFIED 公差参数表					TITLE: 产品名称: 2.54mm Pitch Crimp Terminal			
X.X	±0.30	X.X°	±3°	APPD: 核准: XIE	PART NO: 产品编号: HDGC2550-T-C			
X.XX	±0.30	X.XX°	±2°	CHECK: 校对: WANG	DATE	SCALE	UNIT	CODE NUMBER
X.XXX	±0.10	X.XXX°	±1°	DRAW: 绘图: WANG	2012-12-10	8:1	mm	A008

修订 REV	标记 MARK	修改摘要 REVISION DESCRIPTION	签名 SIGNATURE	日期 DATE
AO		NEW RELEASE	WANG	2012-12-10

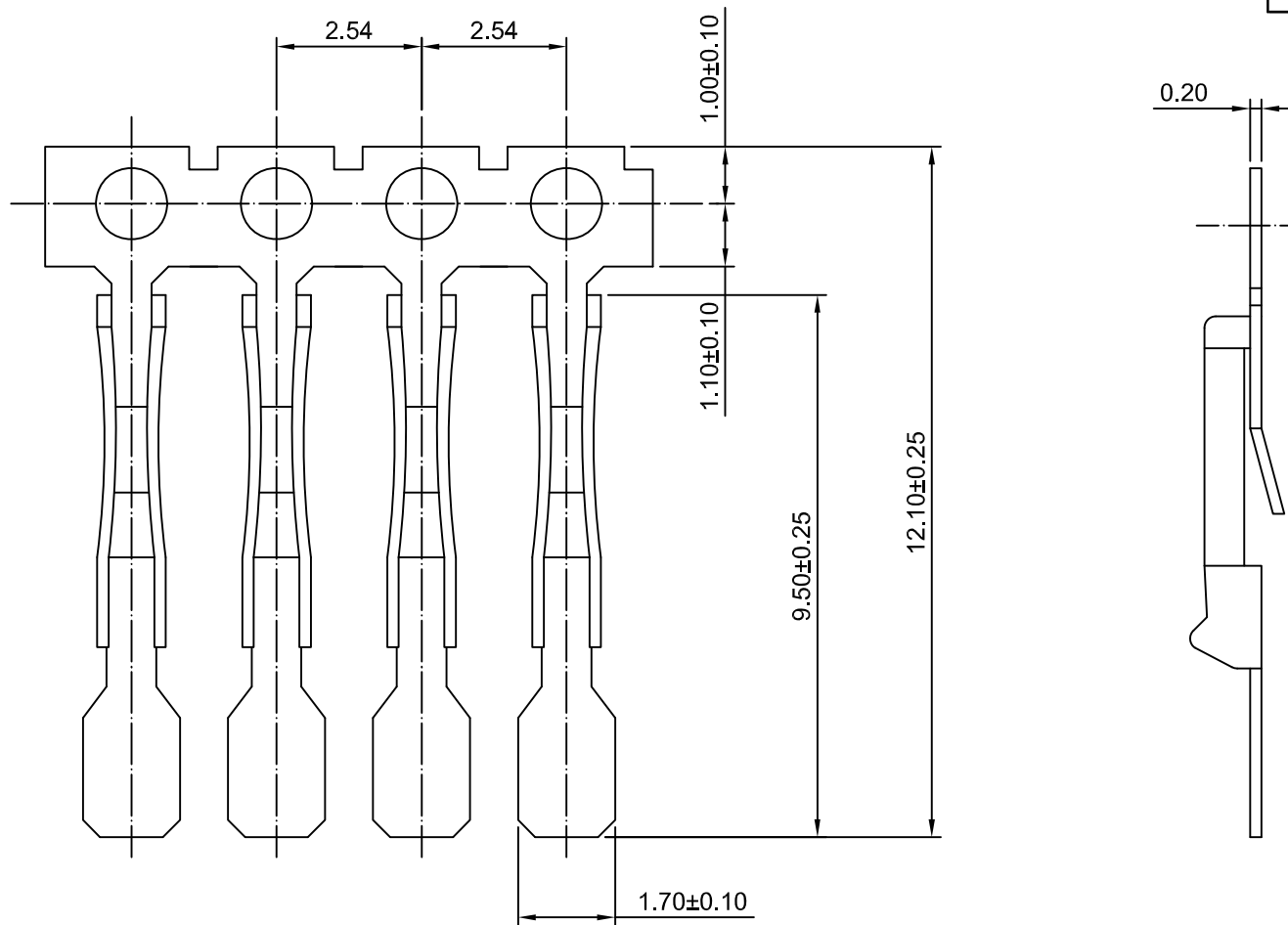

Ordering information & Specifications

Unit:mm

Part No	Wire Range	Insultion O.D.	Material	Finish	Qty/reel
HDGC2550-TP-D	FFC WIRE	-----	Phosphor Bronze	Tin over Nickel	20,000 PCS
HDGC2550-GP-D	FFC WIRE	-----	Phosphor Bronze	Gold over Nickel	20,000 PCS

Optional Gold plating available but MOQ requested

		深圳市华德共创科技有限公司 SHENZHEN HUADE CO-CREATE TECHNOLOGY CO.,LTD TEL : 0755-27129737 FAX : 0755-29940187						
-TOLERANCES- UNLESS OTHERWISE SPECIFIED 公差参数表				TITLE: 2.54mm Pitch 产品名称: Crimp Terminal				
X.X	±0.30	X.X°	±3°	APPD: 核准: XIE	PART NO: 产品编号: HDGC2550-T-D			
X.XX	±0.30	X.XX°	±2°	CHECK: 校对: WANG	DATE	SCALE	UNIT	CODE NUMBER
X.XXX	±0.10	X.XXX°	±1°	DRAW: 绘图: WANG	2012-12-10	8:1	mm	A008

修订 REV	标记 MARK	修改摘要 REVISION DESCRIPTION	签名 SIGNATURE	日期 DATE
AO		NEW RELEASE	WANG	2012-12-10

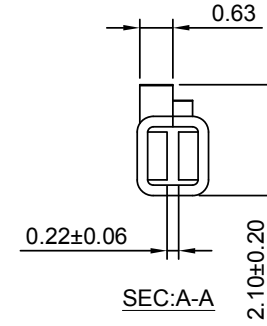
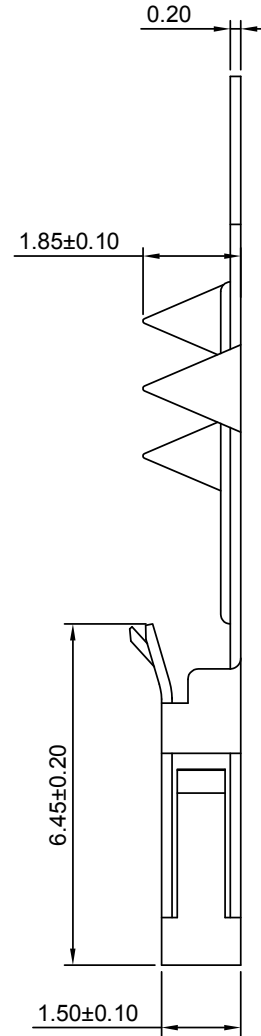
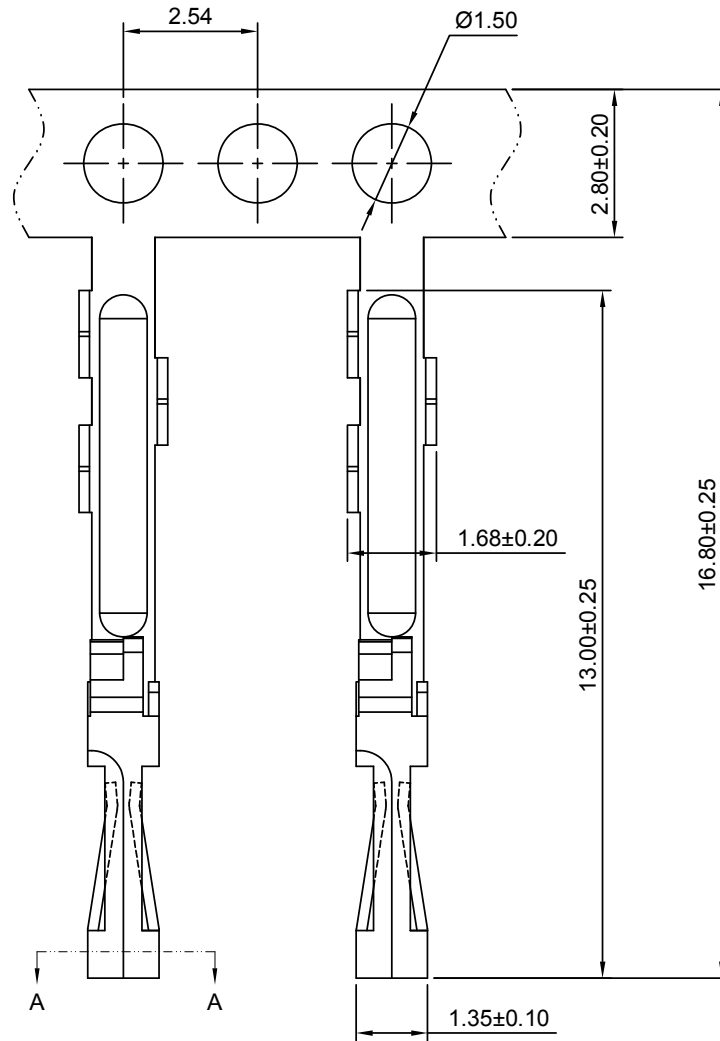

Ordering information & Specifications

Unit:mm

Part No	Wire Range	Insultion O.D.	Material	Finish	Qty/reel
HDGC2550-TP-E	FFC WIRE	----	Phosphor Bronze	Tin over Nickel	15,000 PCS
HDGC2550-GP-E	FFC WIRE	----	Phosphor Bronze	Gold over Nickel	15,000 PCS

Optional Gold plating available but MOQ requested



深圳市华德共创科技有限公司

SHENZHEN HUADE CO-CREATE TECHNOLOGY CO.,LTD

TEL : 0755-27129737 FAX : 0755-29940187

-TOLERANCES- UNLESS OTHERWISE SPECIFIED 公差参数表				TITLE: 产品名称: 2.54mm Pitch Crimp Terminal	
X.X	±0.30	X.X°	±3°	APPD: 核准: XIE	PART NO: 产品编号: HDGC2550-T-E
X.XX	±0.30	X.XX°	±2°	CHECK: 校对: WANG	DATE
X.XXX	±0.10	X.XXX°	±1°	DRAW: 绘图: WANG	SCALE
					UNIT
					CODE NUMBER
					A008

修订 REV	标记 MARK	修改摘要 REVISION DESCRIPTION	签名 SIGNATURE	日期 DATE
AO		NEW RELEASE	WANG	2012-12-10

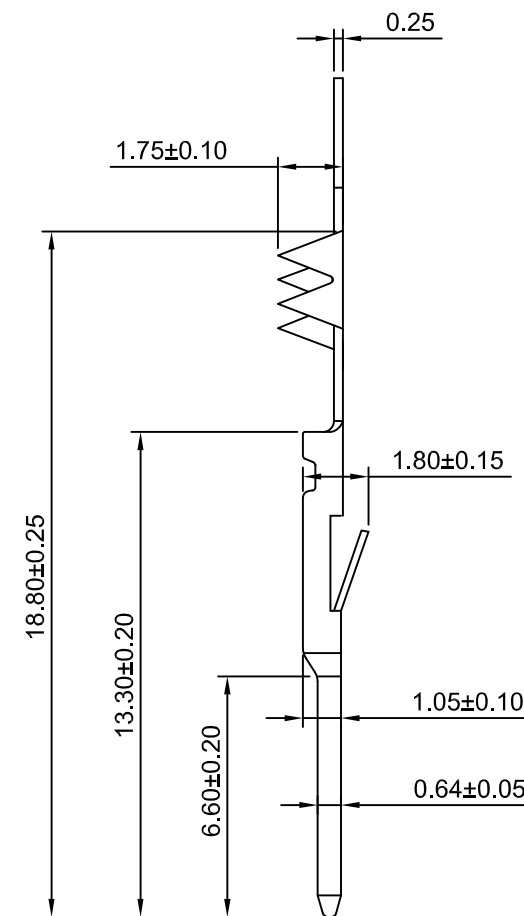
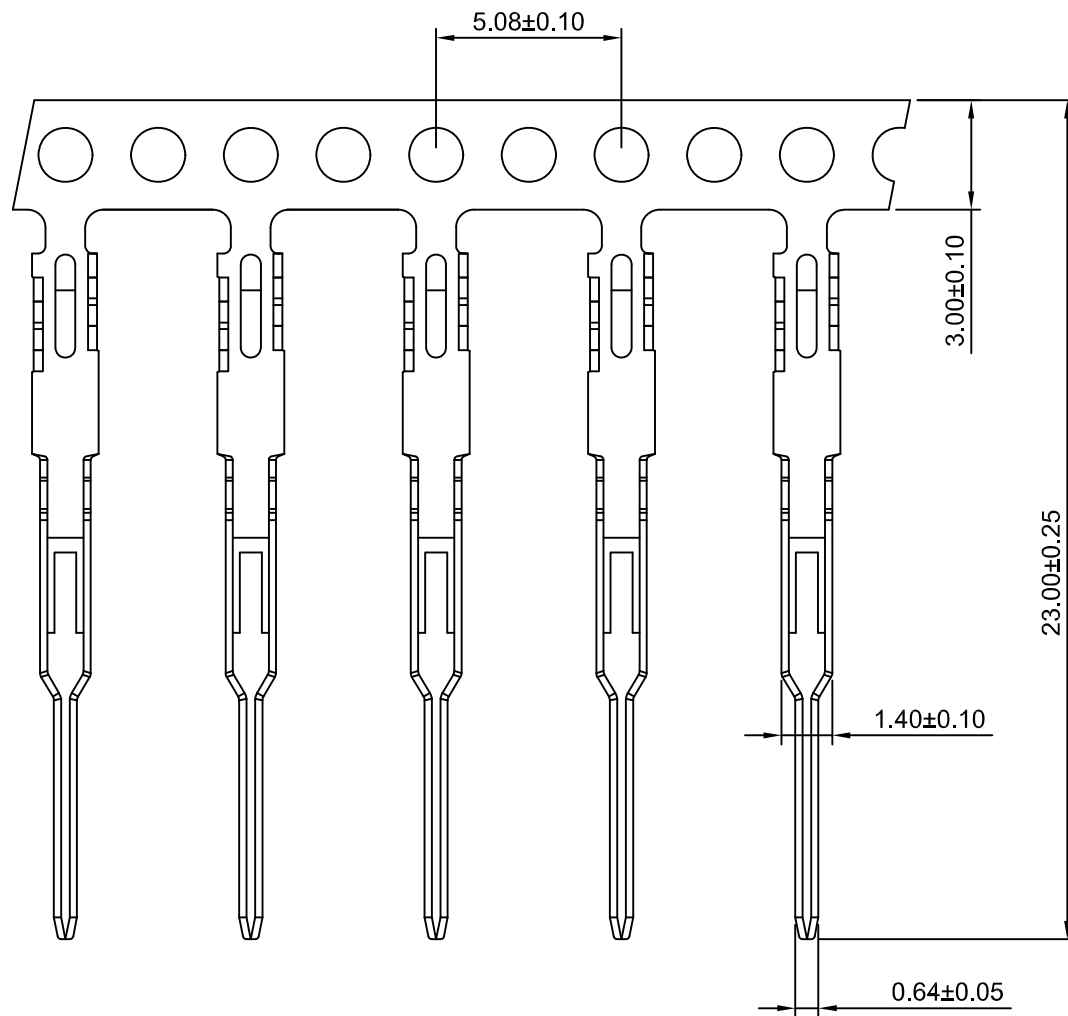

Ordering information & Specifications

Unit:mm

Part No	Wire Range	Insulation O.D.	Material	Finish	Qty/reel
HDGC2550M-TP	FFC WIRE	-----	Phosphor Bronze	Tin over Nickel	10,000 PCS
HDGC2550M-GP	FFC WIRE	-----	Phosphor Bronze	Gold over Nickel	10,000 PCS

Optional Gold plating available but MOQ requested



深圳市华德共创科技有限公司

SHENZHEN HUADE CO-CREATE TECHNOLOGY CO.,LTD

TEL : 0755-27129737 FAX : 0755-29940187

-TOLERANCES- UNLESS OTHERWISE SPECIFIED 公差参数表			TITLE: 产品名称: 2.54mm Pitch Crimp Terminal	
X.X	±0.30	X.X°	±3°	APPD: 核准: XIE
X.XX	±0.30	X.XX°	±2°	CHECK: 校对: WANG
X.XXX	±0.10	X.XXX°	±1°	DRAW: 绘图: WANG
PART NO: 产品编号: HDGC2550M-T		DATE	SCALE	UNIT
		2012-12-10	5:1	mm
		CODE NUMBER	A008	

修订 REV	标记 MARK	修改摘要 REVISION DESCRIPTION	签名 SIGNATURE	日期 DATE
AO		NEW RELEASE	WANG	2012-12-10

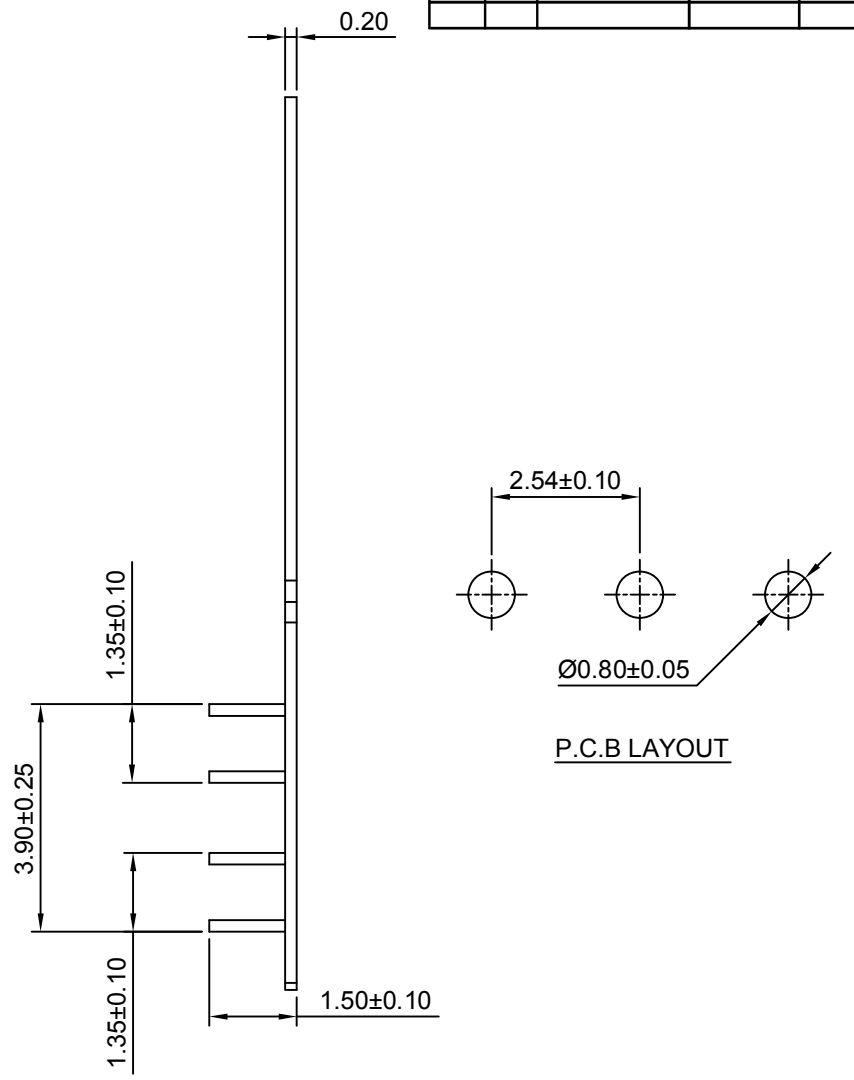
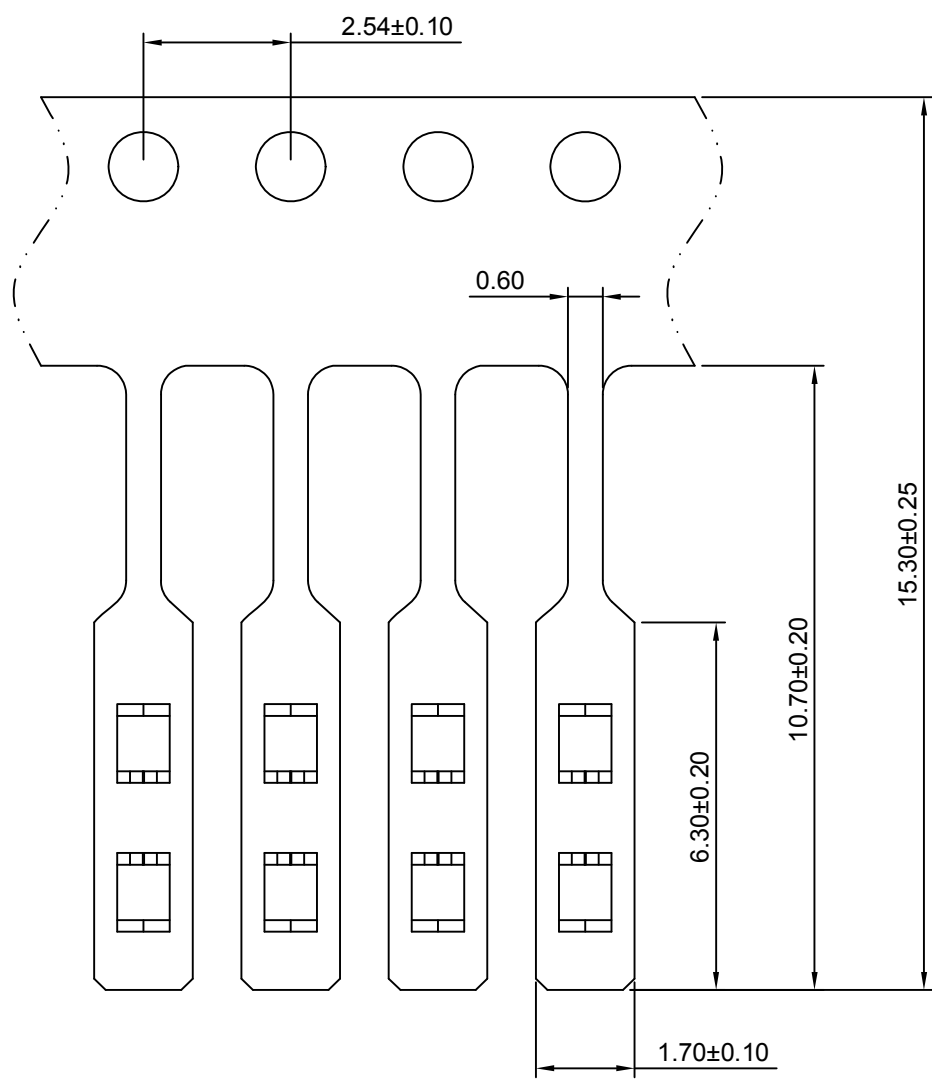

Ordering information & Specifications

Part No	Wire Range	Insultion O.D.	Material	Finish	Qty/reel
HDGC2550M-TP-C	FFC WIRE	-----	Phosphor Bronze	Tin over Nickel	20,000 PCS
HDGC2550M-GP-C	FFC WIRE	-----	Phosphor Bronze	Gold over Nickel	20,000 PCS

Optional Gold plating available but MOQ requested



深圳市华德共创科技有限公司
 SHENZHEN HUADE CO-CREATE TECHNOLOGY CO.,LTD
 TEL : 0755-27129737 FAX : 0755-29940187

-TOLERANCES- UNLESS OTHERWISE SPECIFIED 公差参数表				TITLE: 2.54mm Pitch 产品名称: Crimp Terminal							
X.X	±0.30	X.X°	±3°	APPD: 核准:	XIE			PART NO: 产品编号:	HDGC2550M-T-C		
X.XX	±0.30	X.XX°	±2°	CHECK: 校对:	WANG			DATE	SCALE	UNIT	CODE NUMBER
X.XXX	±0.10	X.XXX°	±1°	DRAW: 绘图:	WANG			2012-12-10	8:1	mm	A008

修订 REV	标记 MARK	修改摘要 REVISION DESCRIPTION	签名 SIGNATURE	日期 DATE
AO		NEW RELEASE	WANG	2012-12-10

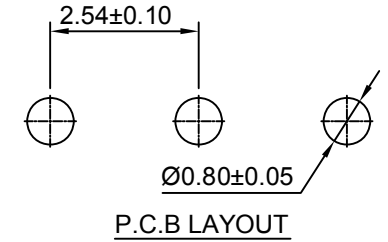
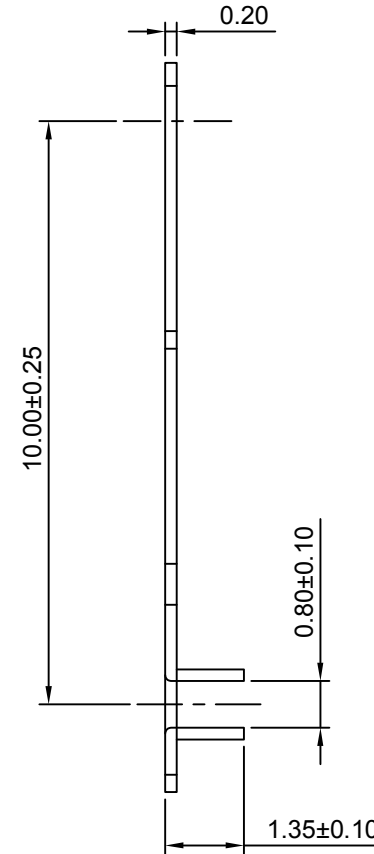
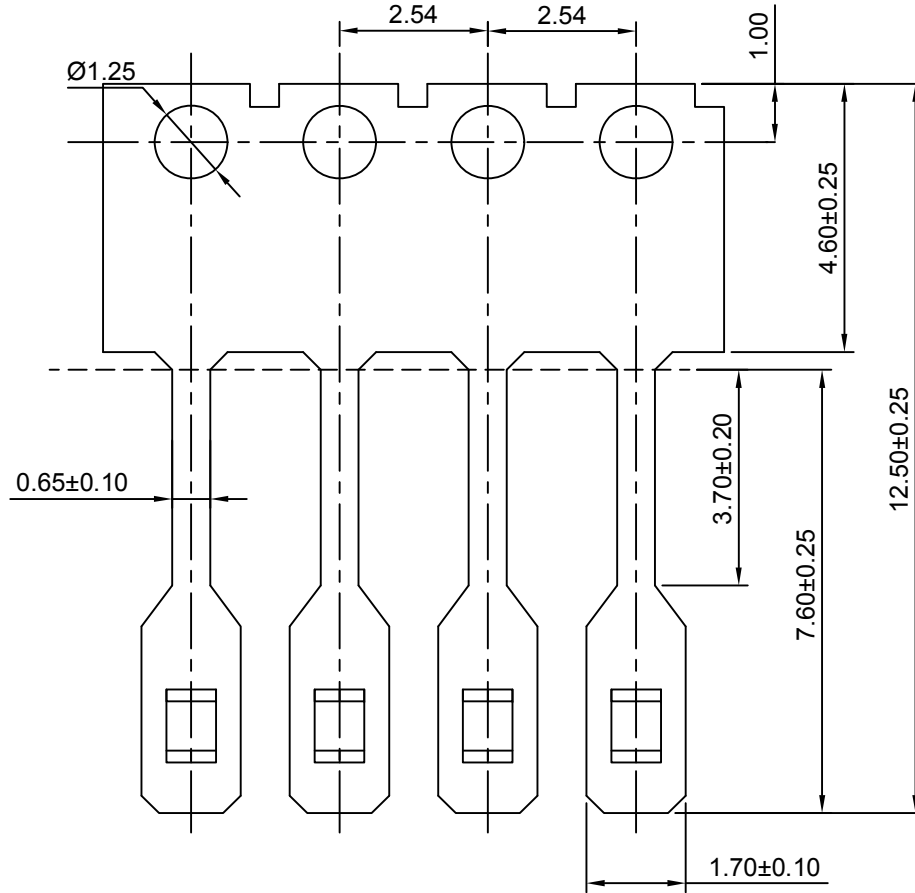

Ordering information & Specifications

Unit:mm

Part No	Wire Range	Insultion O.D.	Material	Finish	Qty/reel
HDGC2550M-TP-CA	FFC WIRE	-----	Phosphor Bronze	Tin over Nickel	20,000 PCS
HDGC2550M-GP-CA	FFC WIRE	-----	Phosphor Bronze	Gold over Nickel	20,000 PCS

Optional Gold plating available but MOQ requested



深圳市华德共创科技有限公司

SHENZHEN HUADE CO-CREATE TECHNOLOGY CO.,LTD

TEL : 0755-27129737 FAX : 0755-29940187

-TOLERANCES- UNLESS OTHERWISE SPECIFIED 公差参数表					TITLE: 2.54mm Pitch 产品名称: Crimp Terminal				
X.X	±0.30	X.X°	±3°	APPD: 核准:	XIE				
X.XX	±0.30	X.XX°	±2°	CHECK: 校对:	WANG	DATE	SCALE	UNIT	CODE NUMBER
X.XXX	±0.10	X.XXX°	±1°	DRAW: 绘图:	WANG	2012-12-10	8:1	mm	A008

修订 REV	标记 MARK	修改摘要 REVISION DESCRIPTION	签名 SIGNATURE	日期 DATE
AO		NEW RELEASE	WANG	2012-12-10

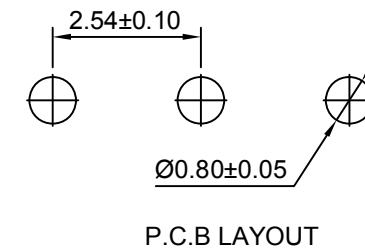
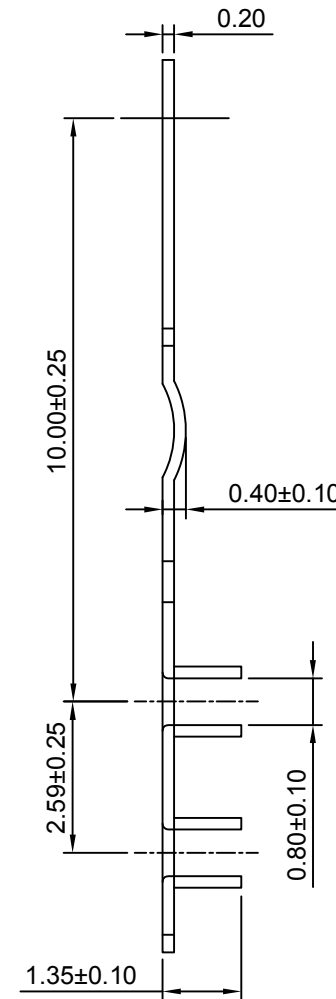
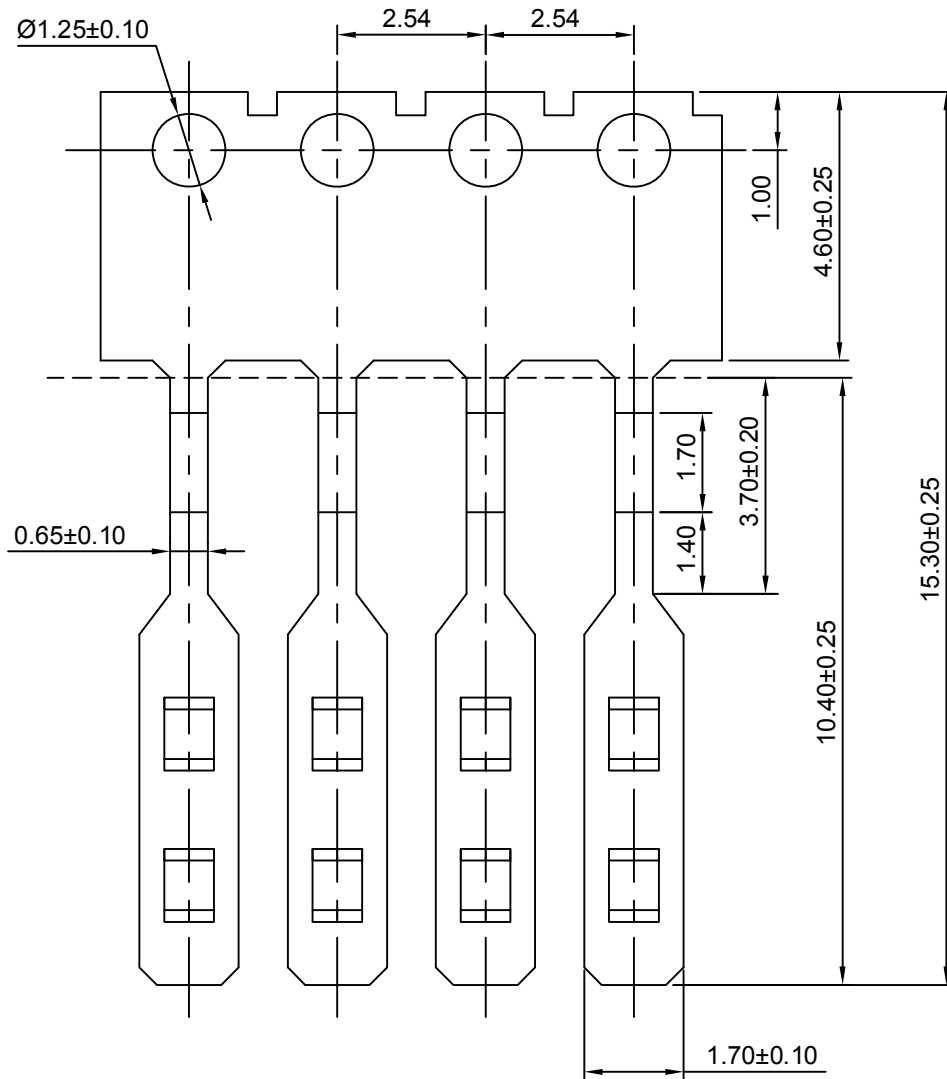

Ordering information & Specifications

Unit:mm

Part No	Wire Range	Insultion O.D.	Material	Finish	Qty/reel
HDGC2550M-TP-C1	FFC WIRE	-----	Phosphor Bronze	Tin over Nickel	20,000 PCS
HDGC2550M-GP-C1	FFC WIRE	-----	Phosphor Bronze	Gold over Nickel	20,000 PCS

Optional Gold plating available but MOQ requested



深圳市华德共创科技有限公司

SHENZHEN HUADE CO-CREATE TECHNOLOGY CO.,LTD

TEL : 0755-27129737 FAX : 0755-29940187

-TOLERANCES- UNLESS OTHERWISE SPECIFIED 公差参数表					TITLE: 产品名称 :	2.54mm Pitch Crimp Terminal			
X.X	±0.30	X.X°	±3°	APPD: 核准 :	XIE	PART NO: 产品编号 : HDGC2550M-T-C1			
X.XX	±0.30	X.XX°	±2°	CHECK: 校对 :	WANG	DATE	SCALE	UNIT	CODE NUMBER
X.XXX	±0.10	X.XXX°	±1°	DRAW: 绘图 :	WANG	2012-12-10	8:1	mm	A008

修订 REV	标记 MARK	修改摘要 REVISION DESCRIPTION	签名 SIGNATURE	日期 DATE
AO		NEW RELEASE	WANG	2012-12-10

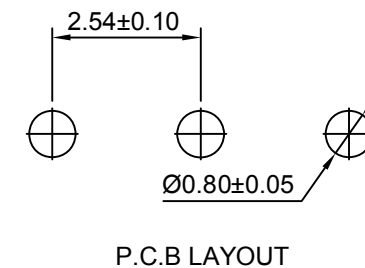
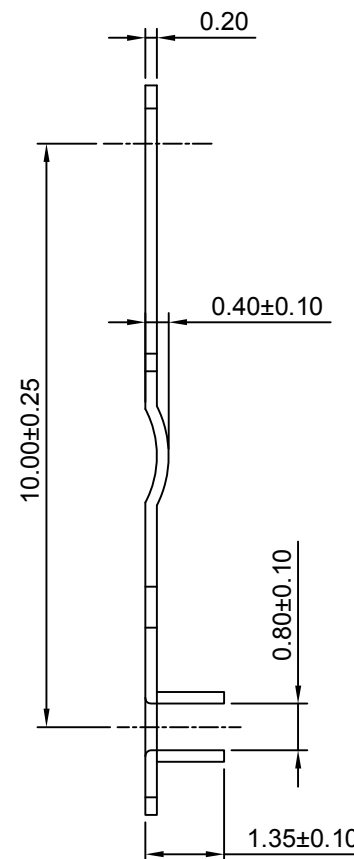
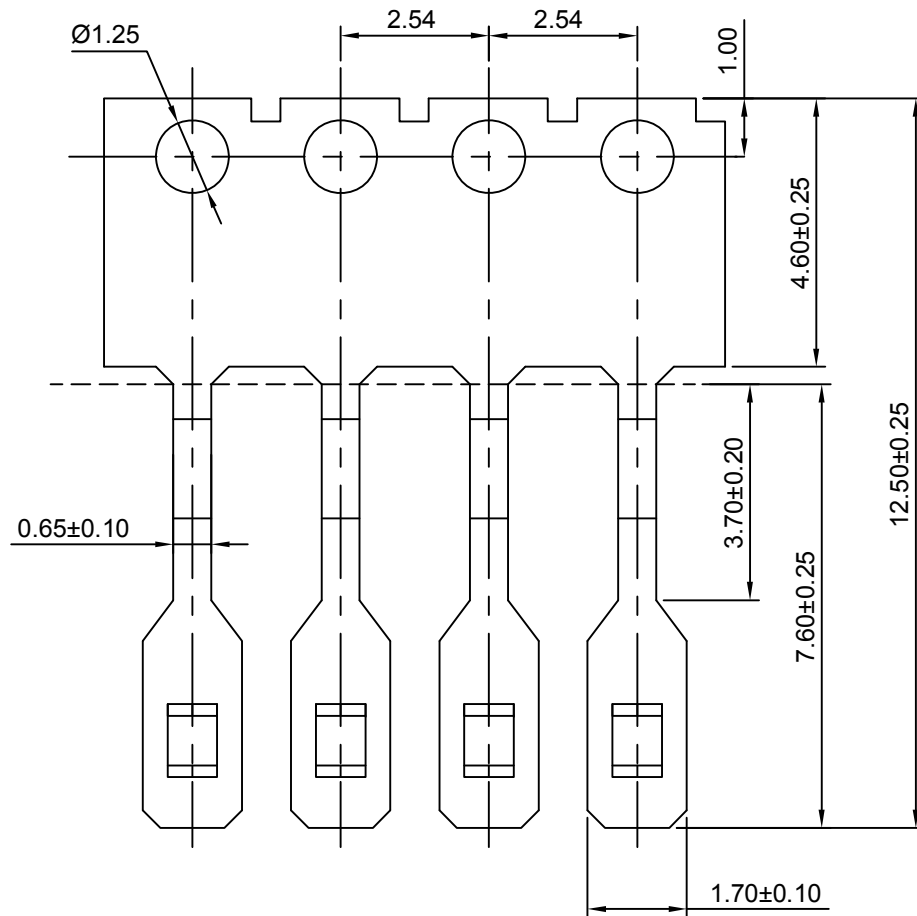

Ordering information & Specifications

Unit:mm

Part No	Wire Range	Insulation O.D.	Material	Finish	Qty/reel
HDGC2550M-TP-C1A	FFC WIRE	-----	Phosphor Bronze	Tin over Nickel	20,000 PCS
HDGC2550M-GP-C1A	FFC WIRE	-----	Phosphor Bronze	Gold over Nickel	20,000 PCS

Optional Gold plating available but MOQ requested



深圳市华德共创科技有限公司

SHENZHEN HUADE CO-CREATE TECHNOLOGY CO.,LTD

TEL : 0755-27129737 FAX : 0755-29940187

-TOLERANCES- UNLESS OTHERWISE SPECIFIED 公差参数表						TITLE: 2.54mm Pitch 产品名称: Crimp Terminal			
X.X	±0.30	X.X°	±3°	APPD: 核准:	XIE	PART NO: 产品编号: HDGC2550M-T-C1A			
X.XX	±0.30	X.XX°	±2°	CHECK: 校对:	WANG	DATE	SCALE	UNIT	CODE NUMBER
X.XXX	±0.10	X.XXX°	±1°	DRAW: 绘图:	WANG	2012-12-10	8:1	mm	A008

修订 REV	标记 MARK	修改摘要 REVISION DESCRIPTION	签名 SIGNATURE	日期 DATE
AO		NEW RELEASE	WANG	2012-12-10

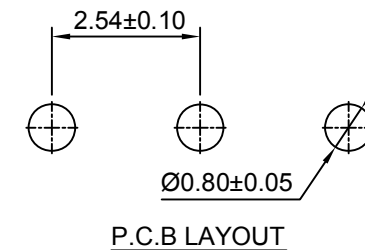
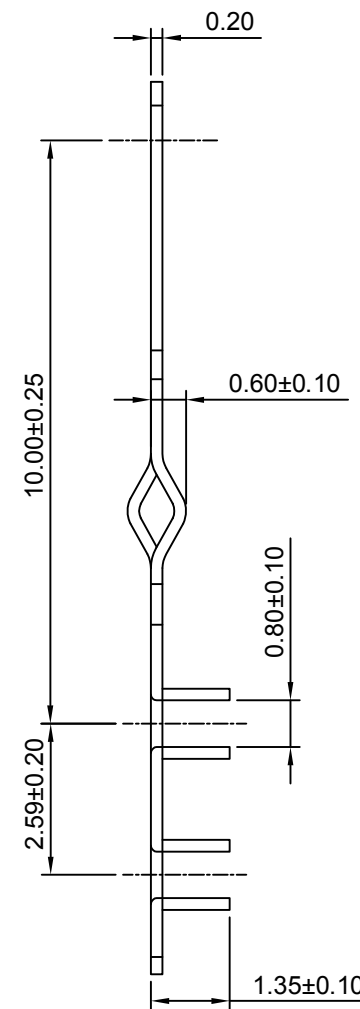
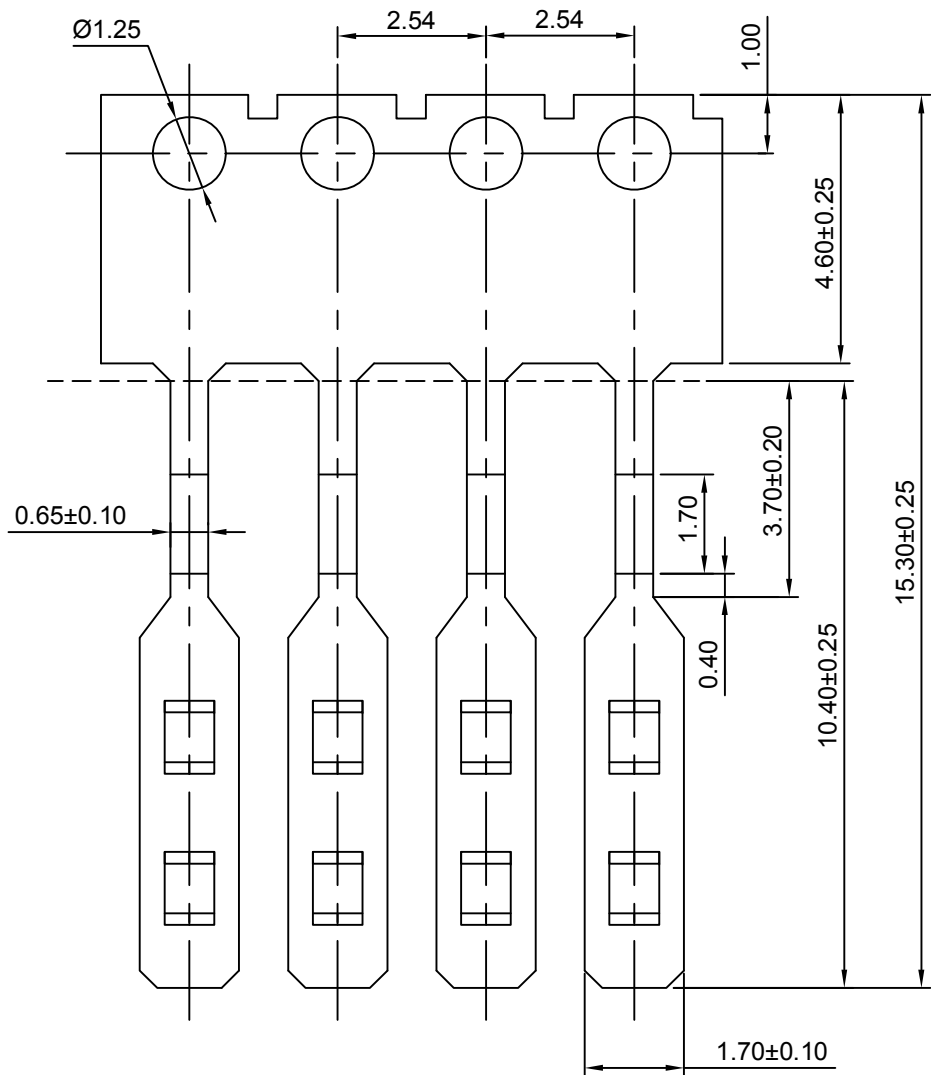

Ordering information & Specifications

Unit:mm

Part No	Wire Range	Insultion O.D.	Material	Finish	Qty/reel
HDGC2550M-TP-C2	FFC WIRE	-----	Phosphor Bronze	Tin over Nickel	20,000 PCS
HDGC2550M-GP-C2	FFC WIRE	-----	Phosphor Bronze	Gold over Nickel	20,000 PCS

Optional Gold plating available but MOQ requested



深圳市华德共创科技有限公司

SHENZHEN HUADE CO-CREATE TECHNOLOGY CO.,LTD

TEL : 0755-27129737 FAX : 0755-29940187

-TOLERANCES- UNLESS OTHERWISE SPECIFIED 公差参数表						TITLE: 产品名称: 2.54mm Pitch Crimp Terminal			
X.X	±0.30	X.X°	±3°	APPD: 核准:	XIE	PART NO: 产品编号: HDGC2550M-T-C2			
X.XX	±0.30	X.XX°	±2°	CHECK: 校对:	WANG	DATE	SCALE	UNIT	CODE NUMBER
X.XXX	±0.10	X.XXX°	±1°	DRAW: 绘图:	WANG	2012-12-10	8:1	mm	A008

修订 REV	标记 MARK	修改摘要 REVISION DESCRIPTION	签名 SIGNATURE	日期 DATE
AO		NEW RELEASE	WANG	2012-12-10

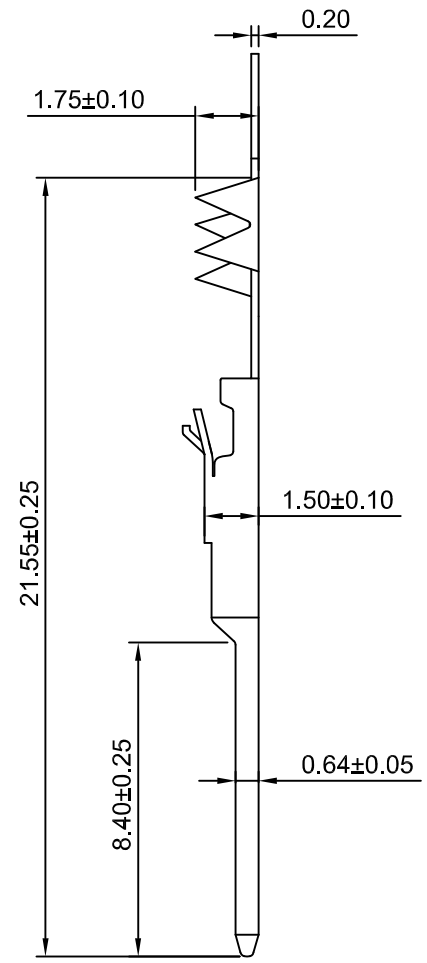
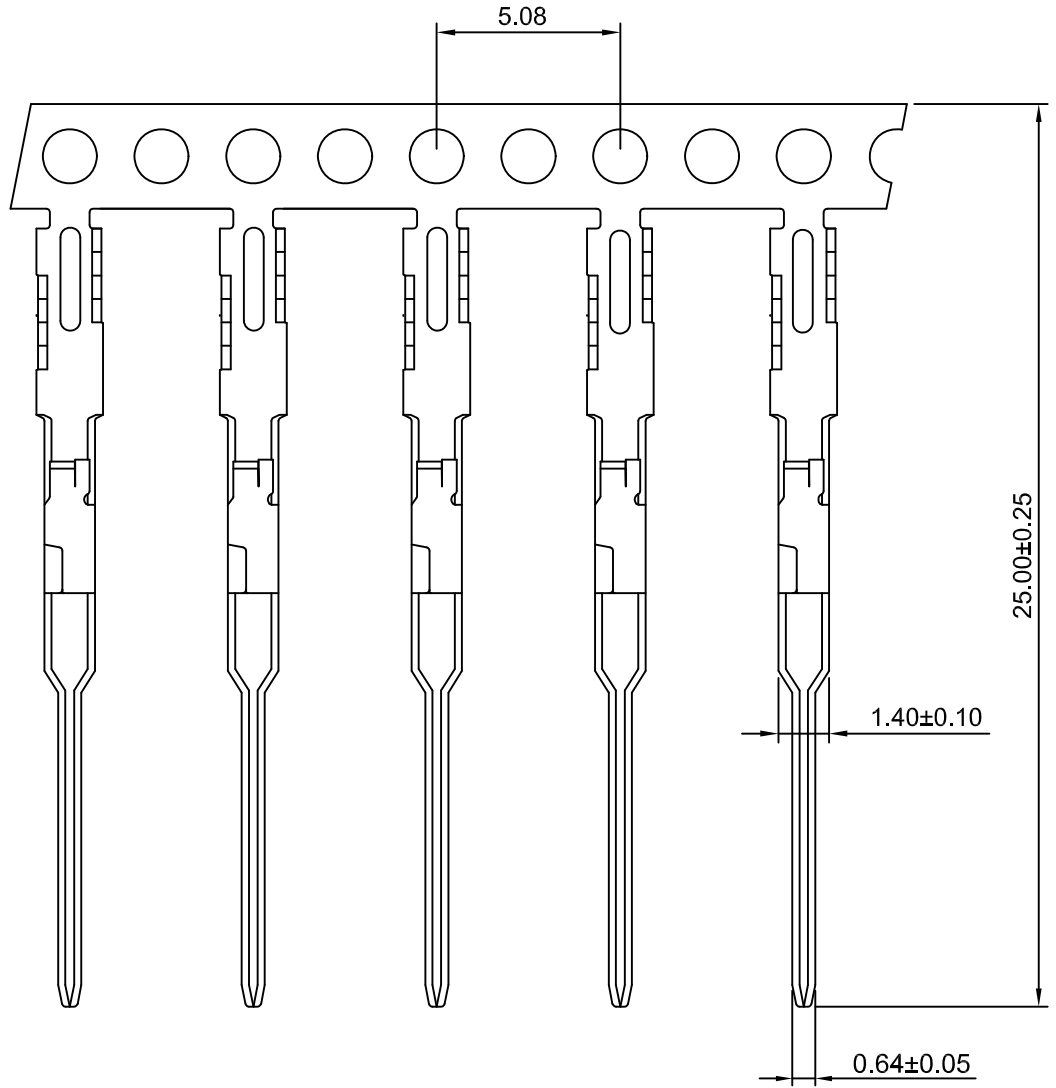

Ordering information & Specifications



Unit:mm

Part No	Wire Range	Insultion O.D.	Material	Finish	Qty/reel
HDGC2550M-TP-D	FFC WIRE	-----	Phosphor Bronze	Tin over Nickel	10,000 PCS
HDGC2550M-GP-D	FFC WIRE	-----	Phosphor Bronze	Gold over Nickel	10,000 PCS

Optional Gold plating available but MOQ requested



深圳市华德共创科技有限公司
 SHENZHEN HUADE CO-CREATE TECHNOLOGY CO.,LTD
 TEL : 0755-27129737 FAX : 0755-29940187

-TOLERANCES- UNLESS OTHERWISE SPECIFIED 公差参数表			 	TITLE: 2.54mm Pitch 产品名称: Crimp Terminal							
X.X	±0.30	X.X°	±3°	APPD: 核准:	XIE			PART NO: 产品编号:	HDGC2550M-T-D		
X.XX	±0.30	X.XX°	±2°	CHECK: 校对:	WANG			DATE	SCALE	UNIT	CODE NUMBER
X.XXX	±0.10	X.XXX°	±1°	DRAW: 绘图:	WANG			2012-12-10	5:1	mm	A008

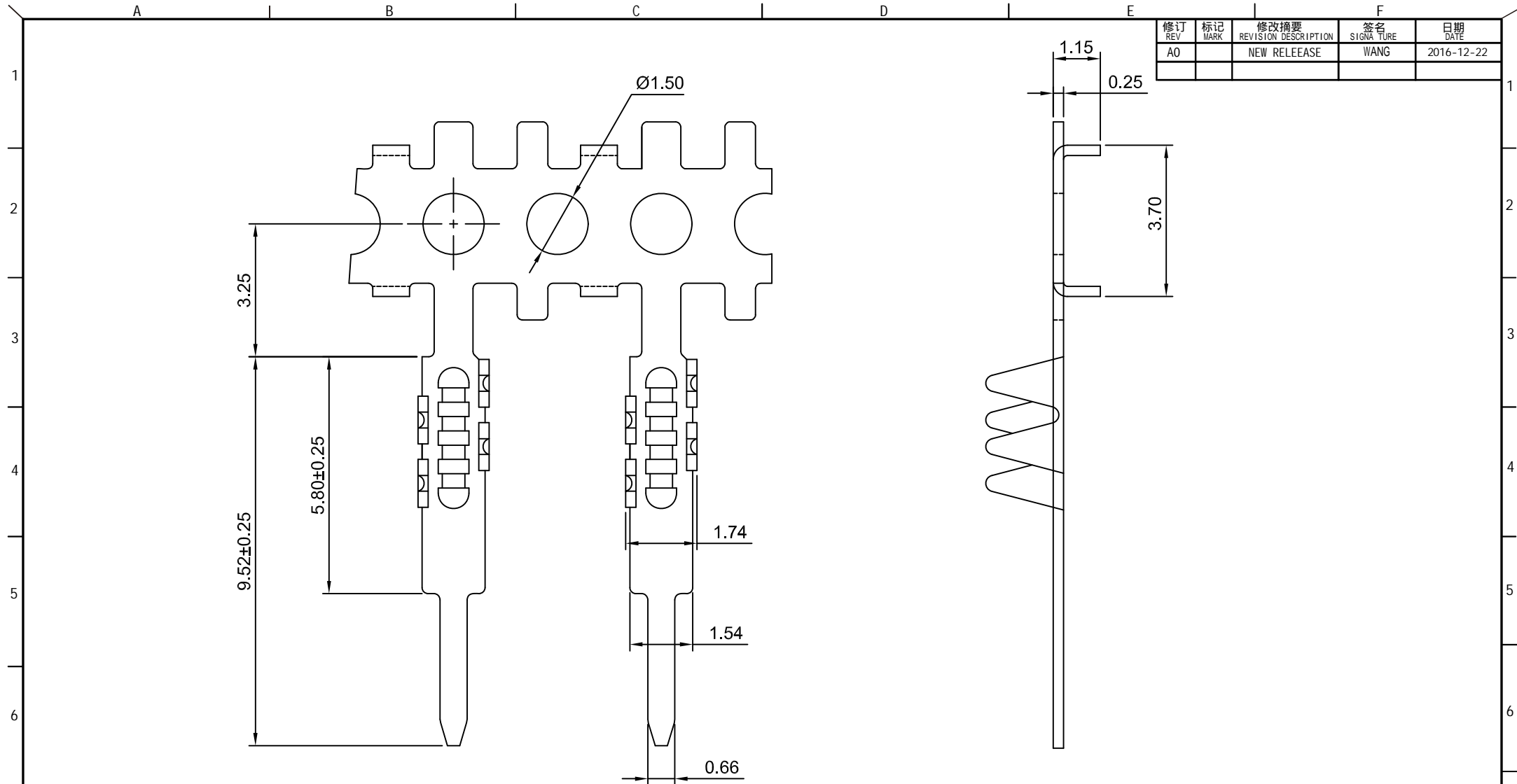

Ordering information & Specifications



Unit:mm

Part No	Wire Range	Insulation O.D.	Material	Finish	Qty/reel
HDGC2550M-TP-E	FFC WIRE	-----	Phosphor Bronze	Tin over Nickel	10,000 PCS
HDGC2550M-GP-E	FFC WIRE	-----	Phosphor Bronze	Gold over Nickel	10,000 PCS

Optional Gold plating available but MOQ requested



深圳市华德共创科技有限公司
 SHENZHEN HUADE CO-CREATE TECHNOLOGY CO.,LTD
 TEL : 0755-27129737 FAX : 0755-29940187

-TOLERANCES- UNLESS OTHERWISE SPECIFIED 公差参数表				 		TITLE: 2.54mm Pitch 产品名称: Crimp Terminal			
X.X	±0.30	X.X°	±3°	APPD: 核准:	XIE	PART NO: 产品编号: HDGC2550M-T-E			
X.XX	±0.30	X.XX°	±2°	CHECK: 校对:	WANG	DATE	SCALE	UNIT	CODE NUMBER
X.XXX	±0.10	X.XXX°	±1°	DRAW: 绘图:	WANG	2016-12-22	8:1	mm	A008

修订 REV	标记 MARK	修改摘要 REVISION DESCRIPTION	签名 SIGNATURE	日期 DATE
AO		NEW RELEASE	WANG	2012-12-10

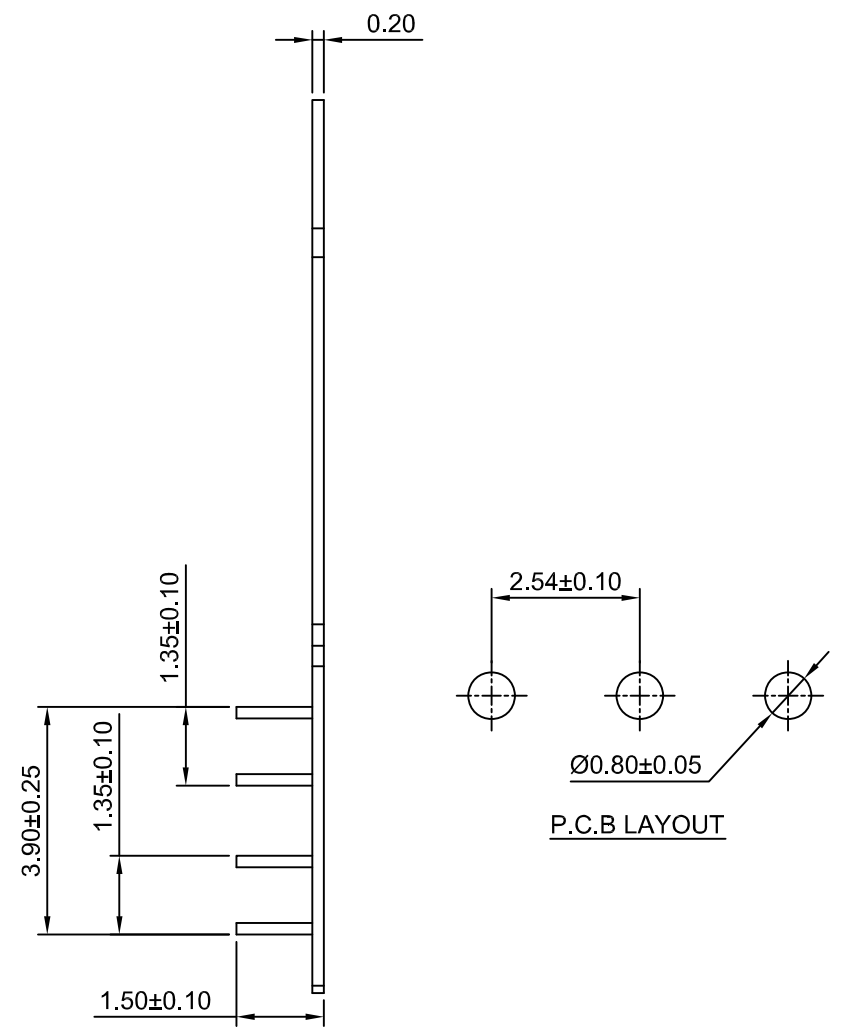
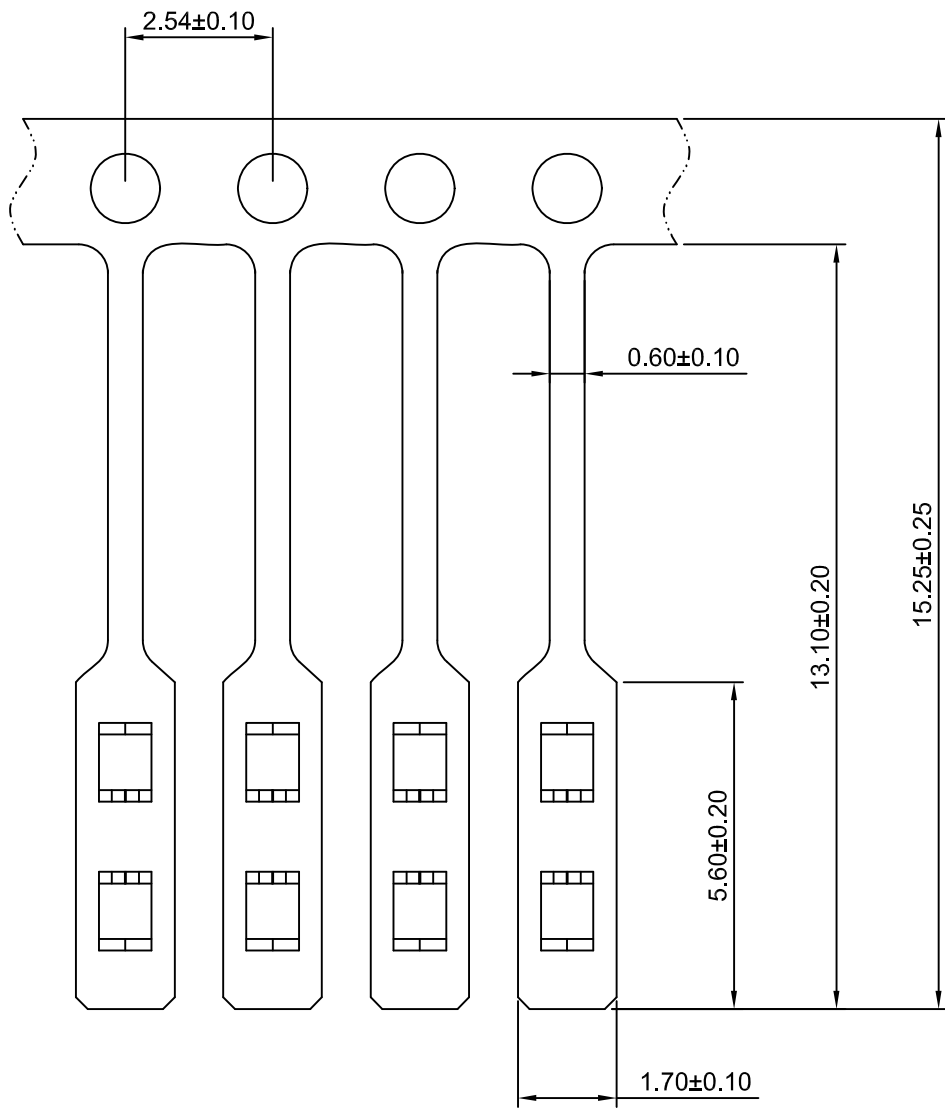

Ordering information & Specifications

Part No	Wire Range	Insulation O.D.	Material	Finish	Qty/reel
HDGC2550M-TP-F	FFC WIRE	-----	Phosphor Bronze	Tin over Nickel	20,000 PCS
HDGC2550M-GP-F	FFC WIRE	-----	Phosphor Bronze	Gold over Nickel	20,000 PCS

Optional Gold plating available but MOQ requested

Unit:mm



深圳市华德共创科技有限公司
 SHENZHEN HUADE CO-CREATE TECHNOLOGY CO.,LTD
 TEL : 0755-27129737 FAX : 0755-29940187

-TOLERANCES- UNLESS OTHERWISE SPECIFIED 公差参数表				TITLE: 2.54mm Pitch 产品名称: Crimp Terminal							
X.X	±0.30	X.X°	±3°	APPD: 核准:	XIE			PART NO: 产品编号:	HDGC2550M-T-F		
X.XX	±0.30	X.XX°	±2°	CHECK: 校对:	WANG			DATE	SCALE	UNIT	CODE NUMBER
X.XXX	±0.10	X.XXX°	±1°	DRAW: 绘图:	WANG			2012-12-10	8:1	mm	A008

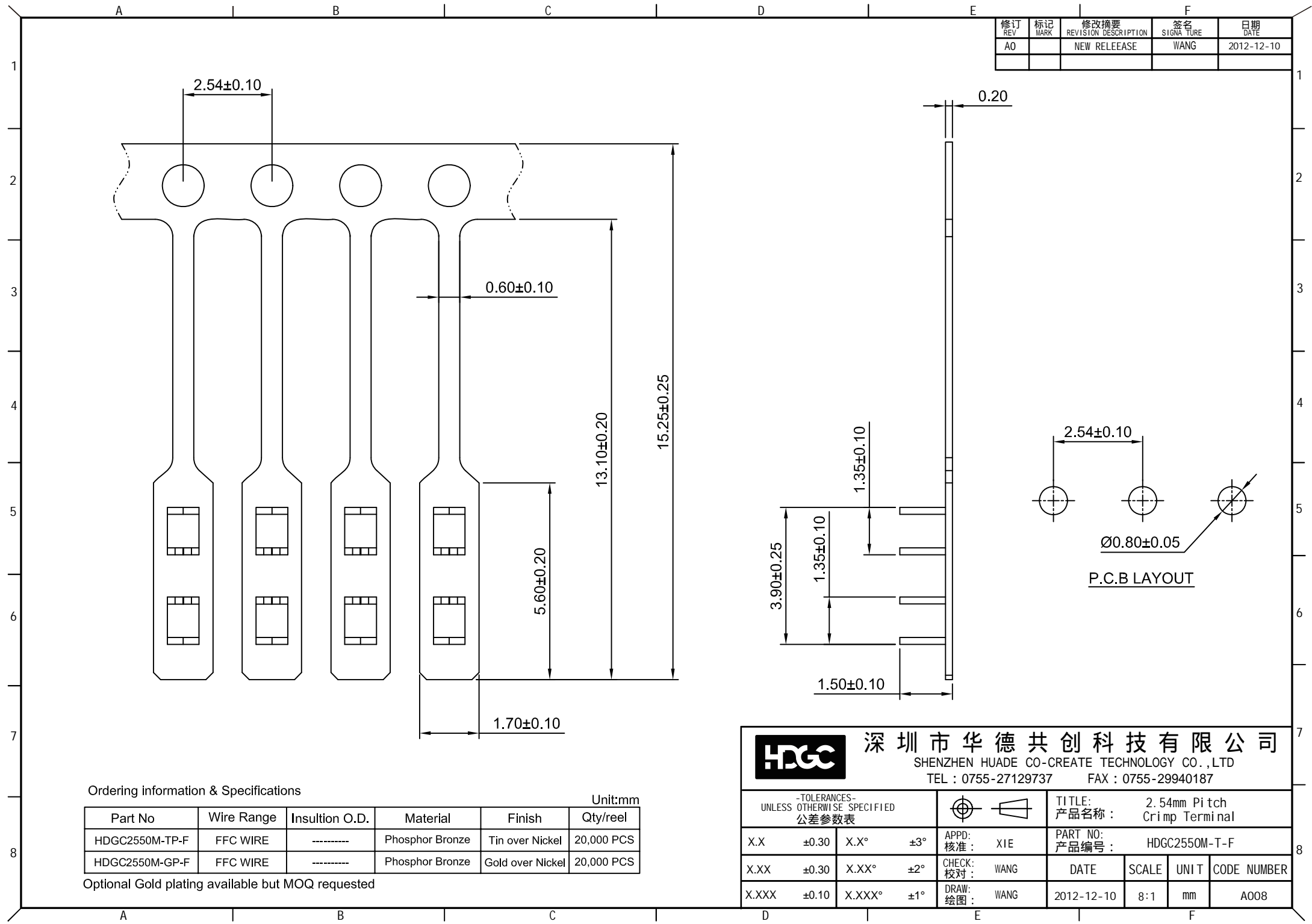

修订 REV	标记 MARK	修改摘要 REVISION DESCRIPTION	签名 SIGNATURE	日期 DATE
AO		NEW RELEASE	WANG	2012-12-10

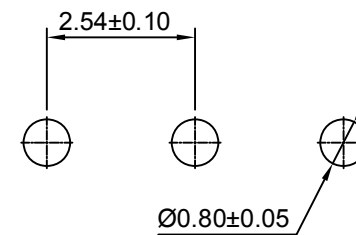
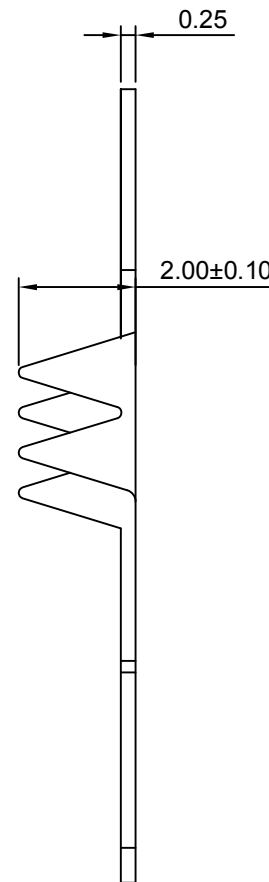
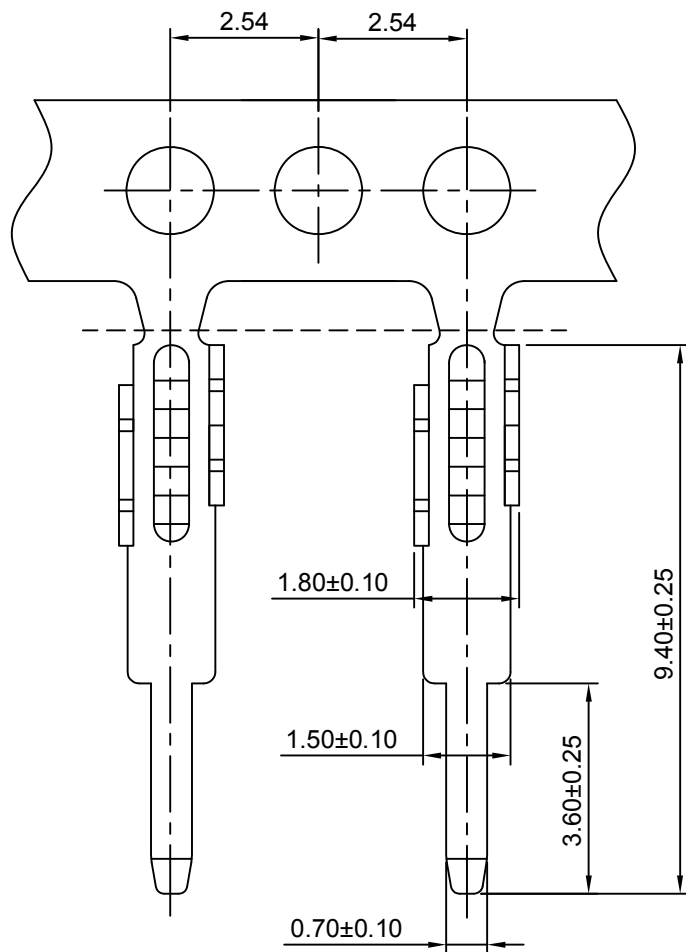

P.C.B LAYOUT

Ordering information & Specifications

Unit:mm

Part No	Wire Range	Insultion O.D.	Material	Finish	Qty/reel
HDGC2550M-TP-G	FFC WIRE	-----	Phosphor Bronze	Tin over Nickel	20,000 PCS
HDGC2550M-GP-G	FFC WIRE	-----	Phosphor Bronze	Gold over Nickel	20,000 PCS

Optional Gold plating available but MOQ requested



深圳市华德共创科技有限公司

SHENZHEN HUADE CO-CREATE TECHNOLOGY CO.,LTD

TEL : 0755-27129737 FAX : 0755-29940187

-TOLERANCES- UNLESS OTHERWISE SPECIFIED 公差参数表					TITLE: 2.54mm Pitch 产品名称: Crimp Terminal				
X.X	±0.30	X.X°	±3°	APPD: 核准:	XIE				
X.XX	±0.30	X.XX°	±2°	CHECK: 校对:	WANG	DATE	SCALE	UNIT	CODE NUMBER
X.XXX	±0.10	X.XXX°	±1°	DRAW: 绘图:	WANG	2012-12-10	8:1	mm	A008

修订 REV	标记 MARK	修改摘要 REVISION DESCRIPTION	签名 SIGNATURE	日期 DATE
AO		NEW RELEASE	WANG	2012-12-10

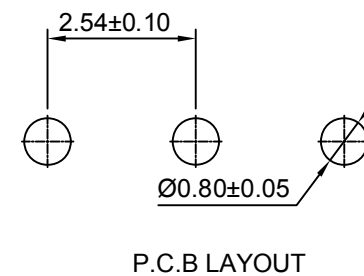
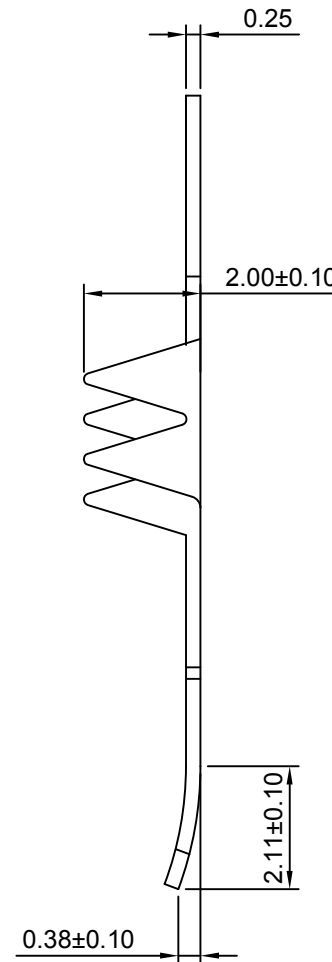
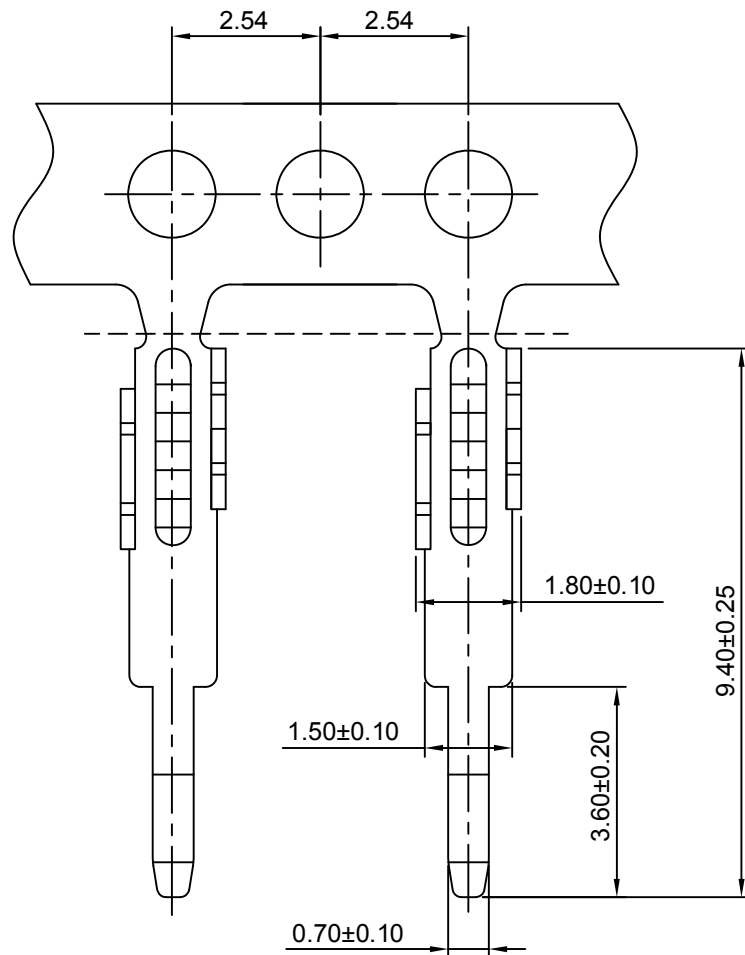

Ordering information & Specifications

Unit:mm

Part No	Wire Range	Insulation O.D.	Material	Finish	Qty/reel
HDGC2550MA-TP-G	FFC WIRE	-----	Phosphor Bronze	Tin over Nickel	20,000 PCS
HDGC2550MA-GP-G	FFC WIRE	-----	Phosphor Bronze	Gold over Nickel	20,000 PCS

Optional Gold plating available but MOQ requested



深圳市华德共创科技有限公司

SHENZHEN HUADE CO-CREATE TECHNOLOGY CO.,LTD

TEL : 0755-27129737 FAX : 0755-29940187

-TOLERANCES- UNLESS OTHERWISE SPECIFIED 公差参数表					TITLE: 2.54mm Pitch 产品名称: Crimp Terminal				
X.X	±0.30	X.X°	±3°	APPD: 核准:	XIE				
X.XX	±0.30	X.XX°	±2°	CHECK: 校对:	WANG	DATE	SCALE	UNIT	CODE NUMBER
X.XXX	±0.10	X.XXX°	±1°	DRAW: 绘图:	WANG	2012-12-10	8:1	mm	A008

修订 REV	标记 MARK	修改摘要 REVISION DESCRIPTION	签名 SIGNATURE	日期 DATE
AO		NEW RELEASE	WANG	2012-12-10

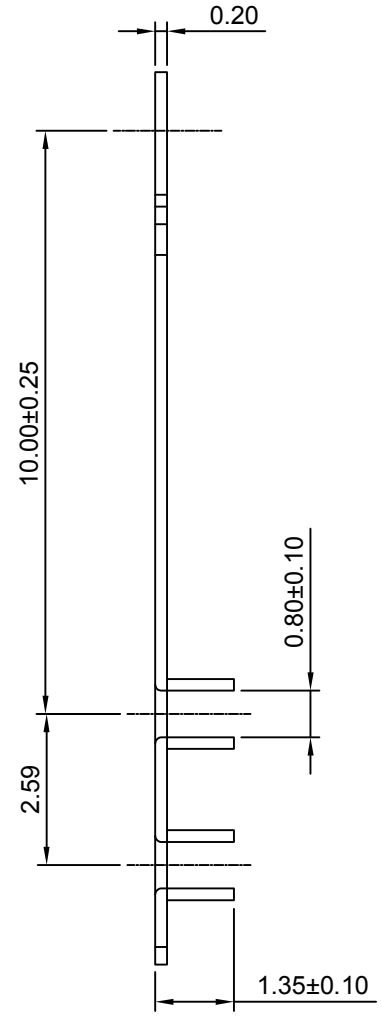
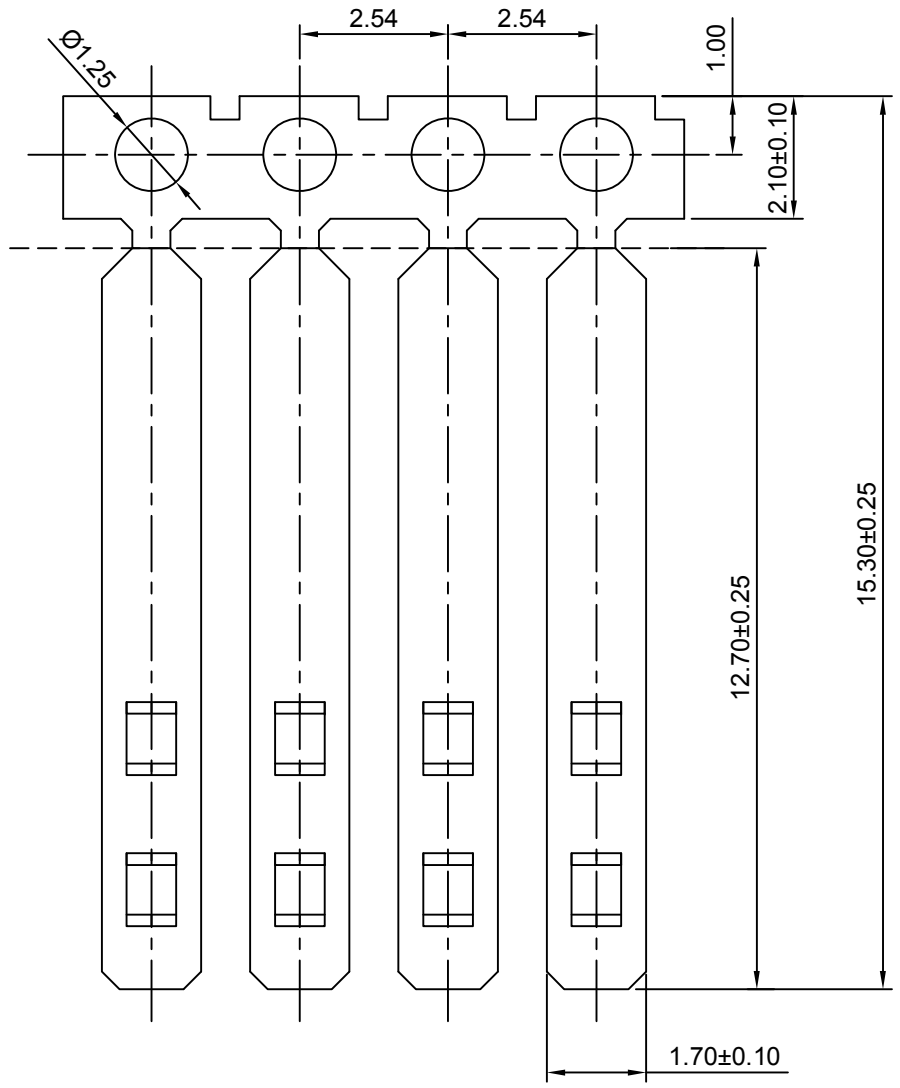

Ordering information & Specifications

Part No	Wire Range	Insulation O.D.	Material	Finish	Qty/reel
HDGC2550M-TP-J	FFC WIRE	-----	Phosphor Bronze	Tin over Nickel	20,000 PCS
HDGC2550M-GP-J	FFC WIRE	-----	Phosphor Bronze	Gold over Nickel	20,000 PCS

Optional Gold plating available but MOQ requested



深圳市华德共创科技有限公司

SHENZHEN HUADE CO-CREATE TECHNOLOGY CO.,LTD
TEL : 0755-27129737 FAX : 0755-29940187

-TOLERANCES- UNLESS OTHERWISE SPECIFIED 公差参数表					TITLE: 2.54mm Pitch 产品名称: Crimp Terminal				
X.X	±0.30	X.X°	±3°	APPD: 核准:	XIE				
X.XX	±0.30	X.XX°	±2°	CHECK: 校对:	WANG	DATE	SCALE	UNIT	CODE NUMBER
X.XXX	±0.10	X.XXX°	±1°	DRAW: 绘图:	WANG	2012-12-10	8:1	mm	A008

修订 REV	标记 MARK	修改摘要 REVISION DESCRIPTION	签名 SIGNATURE	日期 DATE
AO		NEW RELEASE	WANG	2012-12-10

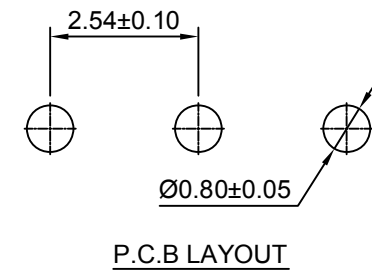
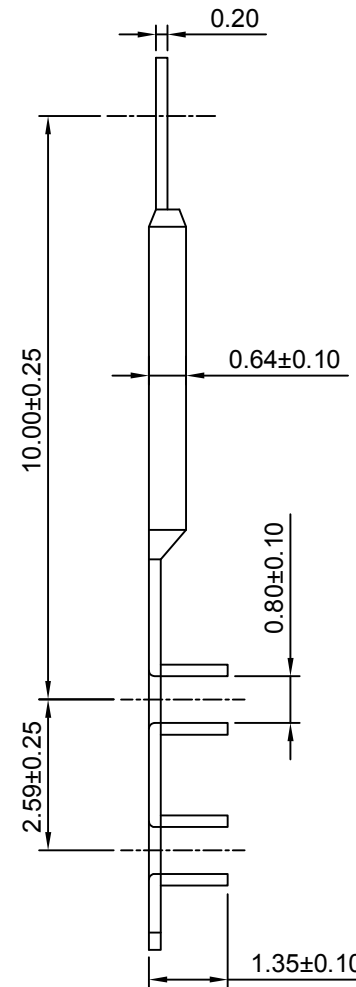
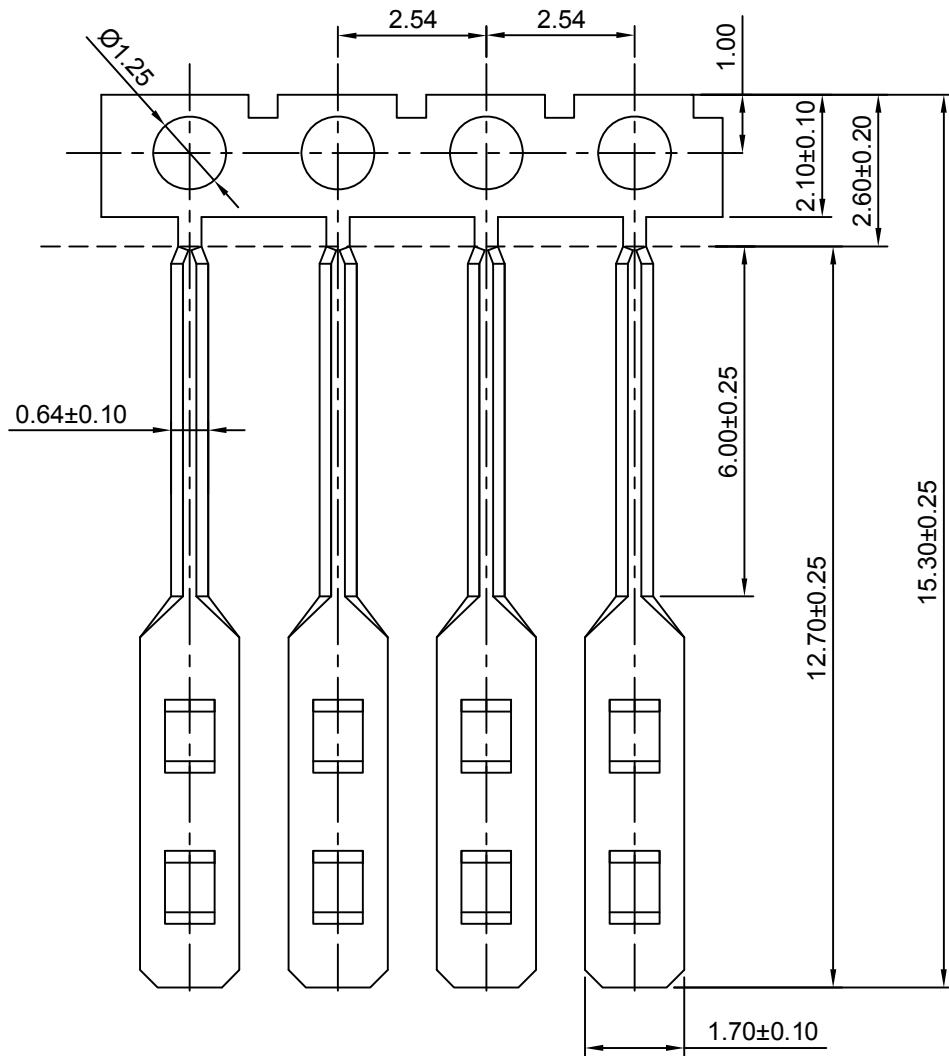

Ordering information & Specifications

Unit:mm

Part No	Wire Range	Insultion O.D.	Material	Finish	Qty/reel
HDGC2550M-TP-K	FFC WIRE	-----	Phosphor Bronze	Tin over Nickel	20,000 PCS
HDGC2550M-GP-K	FFC WIRE	-----	Phosphor Bronze	Gold over Nickel	20,000 PCS

Optional Gold plating available but MOQ requested



深圳市华德共创科技有限公司

SHENZHEN HUADE CO-CREATE TECHNOLOGY CO.,LTD

TEL : 0755-27129737 FAX : 0755-29940187

-TOLERANCES- UNLESS OTHERWISE SPECIFIED 公差参数表				TITLE: 产品名称 : 2.54mm Pitch Crimp Terminal	
X.X	±0.30	X.X°	±3°	APPD: 核准 : XIE	PART NO: 产品编号 : HDGC2550M-T-K
X.XX	±0.30	X.XX°	±2°	CHECK: 校对 : WANG	DATE
X.XXX	±0.10	X.XXX°	±1°	DRAW: 绘图 : WANG	SCALE
					UNIT
					CODE NUMBER
					A008

修订 REV	标记 MARK	修改摘要 REVISION DESCRIPTION	签名 SIGNATURE	日期 DATE
AO		NEW RELEASE	WANG	2012-12-10

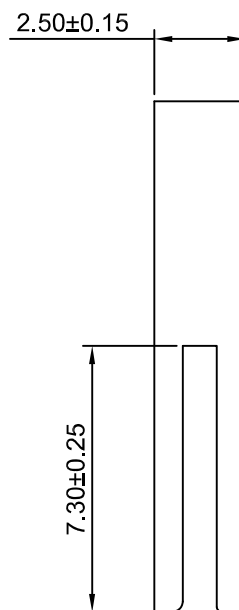
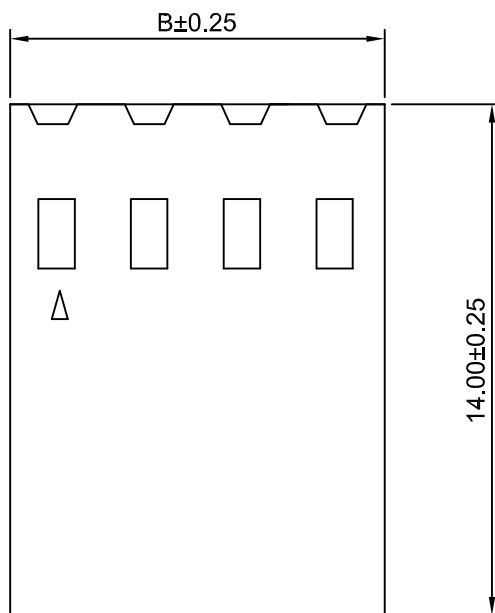
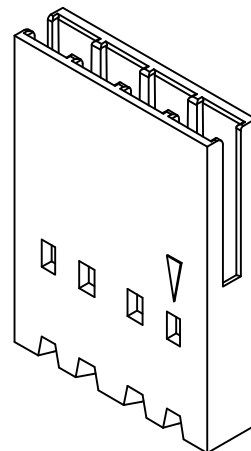
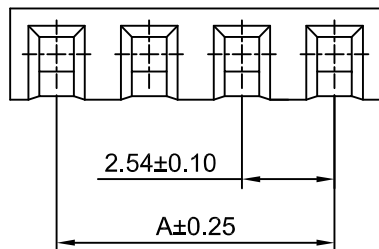

SPECIFICATIONS:

Current Rating: 3A AC,DC
Voltage Rating: 300V AC,DC
Temperature Range: -25°C ~ +85°C
Contact Resistance: 5mΩ Max
Insulation Resistance: 1000MΩ Min
Withstanding Voltage: 1100V AC/minute
Material: PBT30%GF,UL94V-0(Black)

Ordering Information & Dimensions

Circuits	Dimensions(mm)		Circuits	Dimensions(mm)	
	A	B		A	B
2P	2.54	5.08	20P	48.26	50.80
3P	5.08	7.62	21P	50.80	53.34
4P	7.62	10.16	22P	53.34	55.88
5P	10.16	12.70	23P	55.88	58.42
6P	12.70	15.24	24P	58.42	60.96
7P	15.24	17.78	25P	60.96	63.50
8P	17.78	20.32	26P	63.50	66.04
9P	20.32	22.86	27P	66.04	68.58
10P	22.86	25.40	28P	68.58	71.12
11P	25.40	27.94	29P	71.12	73.66
12P	27.94	30.48	30P	73.66	76.20
13P	30.48	33.02	31P	76.20	78.74
14P	33.02	35.56	32P	78.74	81.28
15P	35.56	38.10	33P	81.28	83.82
16P	38.10	40.64	34P	83.82	86.36
17P	40.64	43.18	35P	86.36	88.90
18P	43.18	45.72	36P	88.90	91.44
19P	45.72	48.26			



深圳市华德共创科技有限公司

SHENZHEN HUADE CO-CREATE TECHNOLOGY CO.,LTD

TEL : 0755-27129737 FAX : 0755-29940187

-TOLERANCES- UNLESS OTHERWISE SPECIFIED 公差参数表						TITLE: 2.54mm Pitch Housing 产品名称: 2.54mm Pitch Housing			
X.X	±0.30	X.X°	±3°	APPD: 核准:	XIE	PART NO: 产品编号: HDGC2550H-XP			
X.XX	±0.30	X.XX°	±2°	CHECK: 校对:	WANG	DATE	SCALE	UNIT	CODE NUMBER
X.XXX	±0.10	X.XXX°	±1°	DRAW: 绘图:	WANG	2012-12-10	5:1	mm	A008

修订 REV	标记 MARK	修改摘要 REVISION DESCRIPTION	签名 SIGNATURE	日期 DATE
AO		NEW RELEASE	WANG	2012-12-10

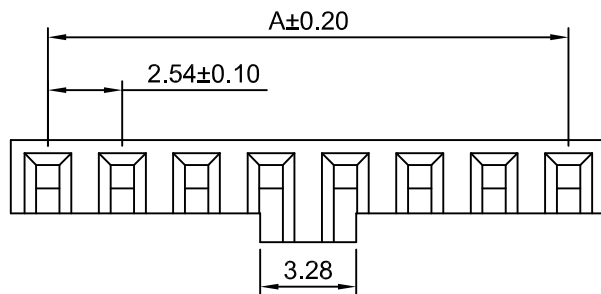

Ordering Information:
HDGC2550HH-N-XP - **
 1
 2

1.Part No.
 2.Color:
 (Blank): Black
 BL:Blue

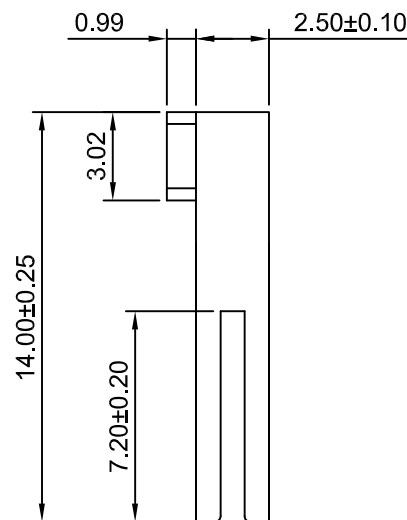
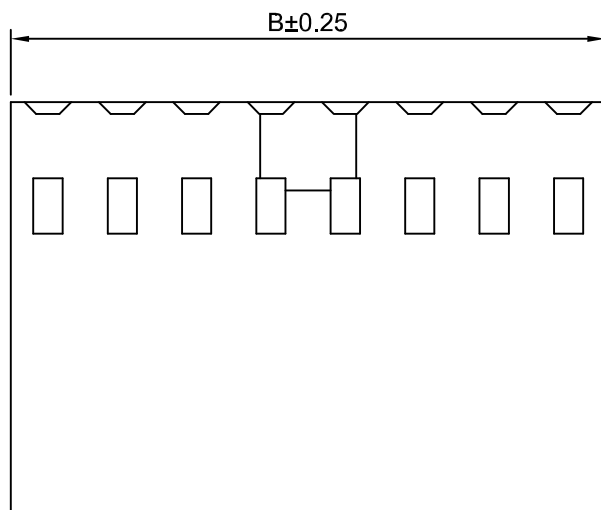

SPECIFICATIONS:

Current Rating: 3A AC,DC
 Voltage Rating: 300V AC,DC
 Temperature Range: -25°C ~ +85°C
 Contact Resistance: 5mΩ Max
 Insulation Resistance: 1000MΩ Min
 Withstanding Voltage: 1100V AC/minute
 Material: PBT+30%GF,UL94V-0(Black)

Ordering Information & Dimensions

Circuits	Dimensions(mm)		Circuits	Dimensions(mm)	
	A	B		A	B
2P	2.54	5.08	14P	33.02	35.56
3P	5.08	7.62	15P	35.56	38.10
4P	7.62	10.16	16P	38.10	40.64
5P	10.16	12.70	17P	40.64	43.18
6P	12.70	15.24	18P	43.18	45.72
7P	15.24	17.78	19P	45.72	48.26
8P	17.78	20.32	20P	48.26	50.80
9P	20.32	22.86	21P	50.80	53.34
10P	22.86	25.40	22P	53.34	55.88
11P	25.40	27.94	23P	55.88	58.42
12P	27.94	30.48	24P	58.42	60.96
13P	30.48	33.02	25P	60.96	63.50

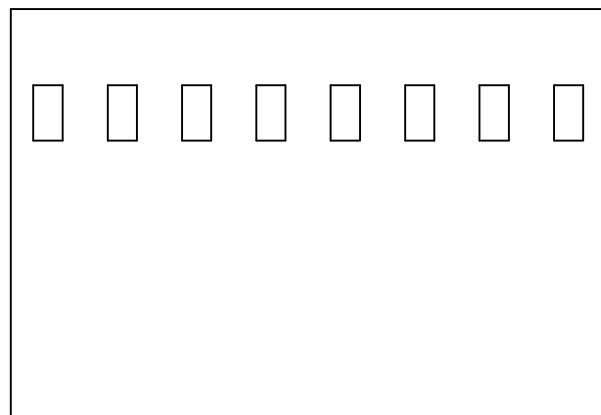



深圳市华德共创科技有限公司
 SHENZHEN HUADE CO-CREATE TECHNOLOGY CO.,LTD
 TEL : 0755-27129737 FAX : 0755-29940187

-TOLERANCES- UNLESS OTHERWISE SPECIFIED 公差参数表				TITLE: 2.54mm Pitch Housing 产品名称: 2.54mm Pitch Housing				
X.X	±0.30	X.X°	±3°	APPD: 核准:	XIE			
X.XX	±0.30	X.XX°	±2°	CHECK: 校对:	WANG			
X.XXX	±0.10	X.XXX°	±1°	DRAW: 绘图:	WANG			
				PART NO: 产品编号:	HDGC2550HH-N-XP			
				DATE	SCALE	UNIT	CODE NUMBER	
				2012-12-10	4:1	mm	A008	

修订 REV	标记 MARK	修改摘要 REVISION DESCRIPTION	签名 SIGNATURE	日期 DATE
AO		NEW RELEASE	WANG	2012-12-10

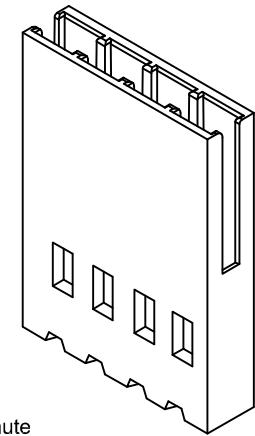
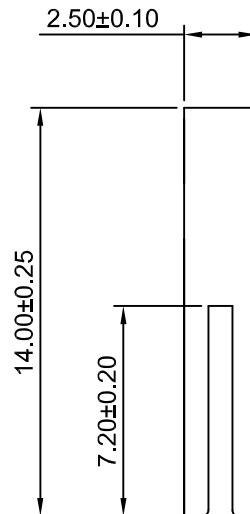
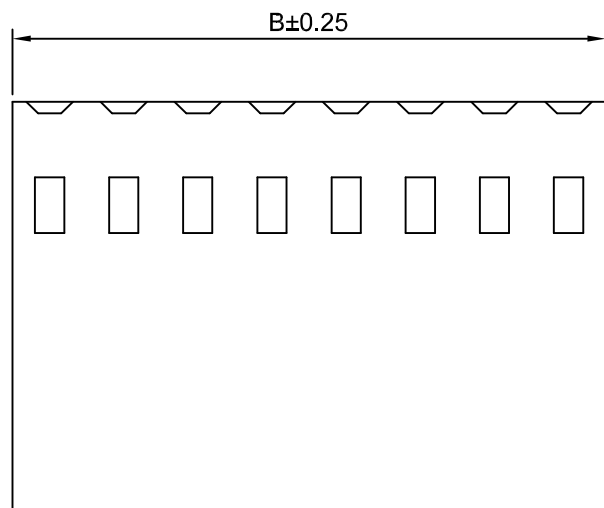
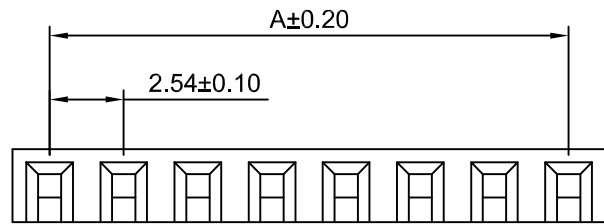

SPECIFICATIONS:

Current Rating: 3A AC,DC
Voltage Rating: 300V AC,DC
Temperature Range: $-25^{\circ}\text{C} \sim +85^{\circ}\text{C}$
Contact Resistance: 5mΩ Max
Insulation Resistance: 1000MΩ Min
Withstanding Voltage: 1100V AC/minute
Material: PBT30%GF,UL94V-0(Black)

Ordering Information & Dimensions

Circuits	Dimensions(mm)		Circuits	Dimensions(mm)	
	A	B		A	B
2P	2.54	5.08	14P	33.02	35.56
3P	5.08	7.62	15P	35.56	38.10
4P	7.62	10.16	16P	38.10	40.64
5P	10.16	12.70	17P	40.64	43.18
6P	12.70	15.24	18P	43.18	45.72
7P	15.24	17.78	19P	45.72	48.26
8P	17.78	20.32	20P	48.26	50.80
9P	20.32	22.86	21P	50.80	53.34
10P	22.86	25.40	22P	53.34	55.88
11P	25.40	27.94	23P	55.88	58.42
12P	27.94	30.48	24P	58.42	60.96
13P	30.48	33.02	25P	60.96	63.50

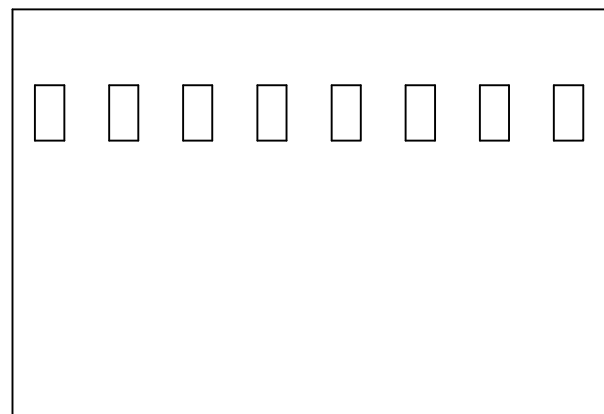

深圳市华德共创科技有限公司

SHENZHEN HUADE CO-CREATE TECHNOLOGY CO.,LTD

TEL : 0755-27129737 FAX : 0755-29940187

-TOLERANCES- UNLESS OTHERWISE SPECIFIED 公差参数表						TITLE: 2.54mm Pitch 产品名称: Housing			
X.X	±0.30	X.X°	±3°	APPD: 核准:	XIE	PART NO: 产品编号: HDGC2550HH-XP			
X.XX	±0.30	X.XX°	±2°	CHECK: 校对:	WANG	DATE	SCALE	UNIT	CODE NUMBER
X.XXX	±0.10	X.XXX°	±1°	DRAW: 绘图:	WANG	2012-12-10	4:1	mm	A008

修订 REV	标记 MARK	修改摘要 REVISION DESCRIPTION	签名 SIGNATURE	日期 DATE
AO		NEW RELEASE	WANG	2012-12-10

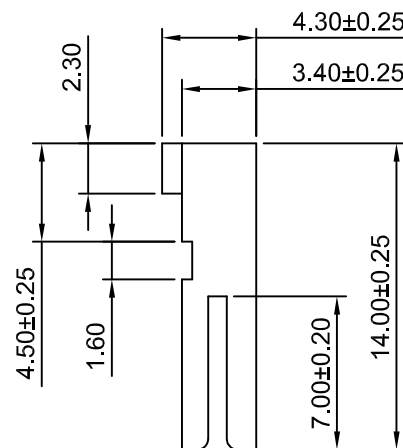
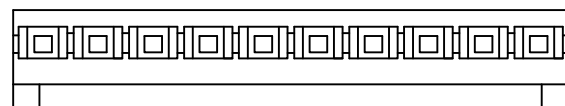
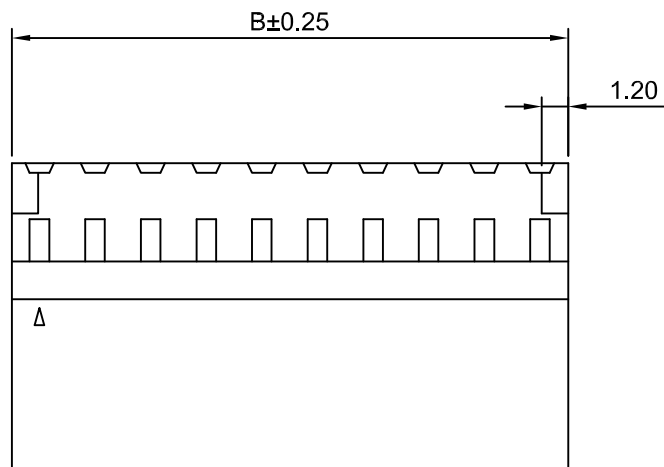
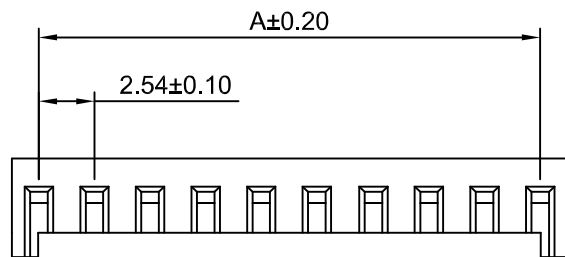

SPECIFICATIONS:

Current Rating: 3A AC,DC
Voltage Rating: 300V AC,DC
Temperature Range: $-25^{\circ}\text{C} \sim +85^{\circ}\text{C}$
Contact Resistance: 5mΩ Max
Insulation Resistance: 1000MΩ Min
Withstanding Voltage: 1100V AC/minute
Material: PBT30%GF,UL94V-0(Black)

Ordering Information & Dimensions

Circuits	Dimensions(mm)		Circuits	Dimensions(mm)	
	A	B		A	B
2P	2.54	5.08	14P	33.02	35.56
3P	5.08	7.62	15P	35.56	38.10
4P	7.62	10.16	16P	38.10	40.64
5P	10.16	12.70	17P	40.64	43.18
6P	12.70	15.24	18P	43.18	45.72
7P	15.24	17.78	19P	45.72	48.26
8P	17.78	20.32	20P	48.26	50.80
9P	20.32	22.86	21P	50.80	53.34
10P	22.86	25.40	22P	53.34	55.88
11P	25.40	27.94	23P	55.88	58.42
12P	27.94	30.48	24P	58.42	60.96
13P	30.48	33.02	25P	60.96	63.50



深圳市华德共创科技有限公司

SHENZHEN HUADE CO-CREATE TECHNOLOGY CO.,LTD

TEL : 0755-27129737 FAX : 0755-29940187

-TOLERANCES- UNLESS OTHERWISE SPECIFIED 公差参数表						TITLE: 2.54mm Pitch Housing 产品名称:			
X.X	±0.30	X.X°	±3°	APPD: 核准:	XIE	PART NO: HDGC2550HA-XP 产品编号:			
X.XX	±0.30	X.XX°	±2°	CHECK: 校对:	WANG	DATE	SCALE	UNIT	CODE NUMBER
X.XXX	±0.10	X.XXX°	±1°	DRAW: 绘图:	WANG	2012-12-10	3:1	mm	A008

修订 REV	标记 MARK	修改摘要 REVISION DESCRIPTION	签名 SIGNATURE	日期 DATE
AO		NEW RELEASE	WANG	2012-12-10

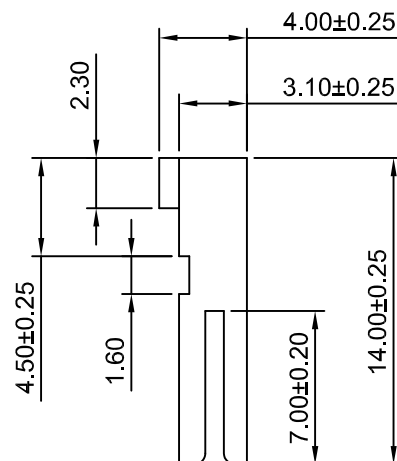
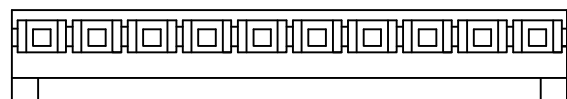
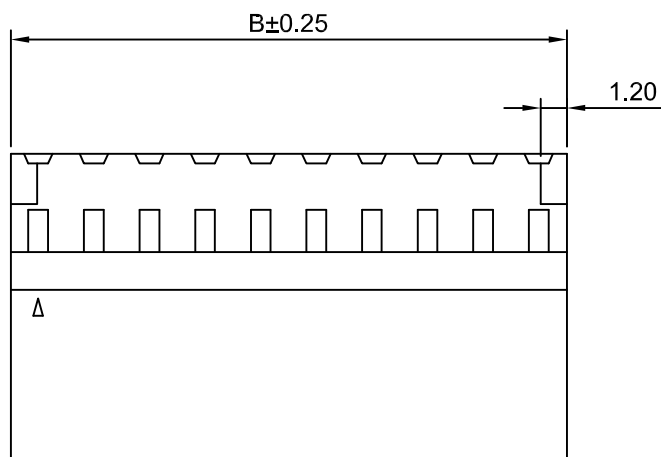
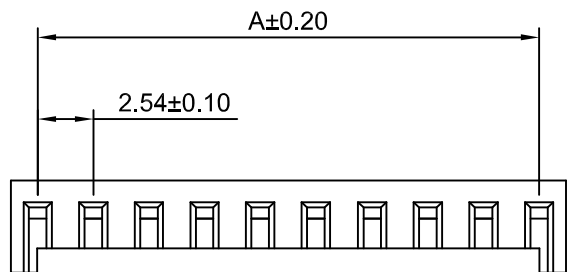

SPECIFICATIONS:

Current Rating: 3A AC,DC
Voltage Rating: 300V AC,DC
Temperature Range: $-25^{\circ}\text{C} \sim +85^{\circ}\text{C}$
Contact Resistance: $5\text{m}\Omega$ Max
Insulation Resistance: $1000\text{M}\Omega$ Min
Withstanding Voltage: 1100V AC/minute
Material: PBT30%GF,UL94V-0(Black)

Ordering Information & Dimensions

Circuits	Dimensions(mm)		Circuits	Dimensions(mm)	
	A	B		A	B
2P	2.54	5.08	14P	33.02	35.56
3P	5.08	7.62	15P	35.56	38.10
4P	7.62	10.16	16P	38.10	40.64
5P	10.16	12.70	17P	40.64	43.18
6P	12.70	15.24	18P	43.18	45.72
7P	15.24	17.78	19P	45.72	48.26
8P	17.78	20.32	20P	48.26	50.80
9P	20.32	22.86	21P	50.80	53.34
10P	22.86	25.40	22P	53.34	55.88
11P	25.40	27.94	23P	55.88	58.42
12P	27.94	30.48	24P	58.42	60.96
13P	30.48	33.02	25P	60.96	63.50



深圳市华德共创科技有限公司

SHENZHEN HUADE CO-CREATE TECHNOLOGY CO.,LTD

TEL : 0755-27129737 FAX : 0755-29940187

-TOLERANCES- UNLESS OTHERWISE SPECIFIED 公差参数表						TITLE: 2.54mm Pitch Housing 产品名称:			
X.X	± 0.30	X.X°	$\pm 3^{\circ}$	APPD: 核准:	XIE	PART NO: 产品编号: HDGC2550HB-XP			
X.XX	± 0.30	X.XX°	$\pm 2^{\circ}$	CHECK: 校对:	WANG	DATE	SCALE	UNIT	CODE NUMBER
X.XXX	± 0.10	X.XXX°	$\pm 1^{\circ}$	DRAW: 绘图:	WANG	2012-12-10	3:1	mm	A008

修订 REV	标记 MARK	修改摘要 REVISION DESCRIPTION	签名 SIGNATURE	日期 DATE
AO		NEW RELEASE	WANG	2012-12-10

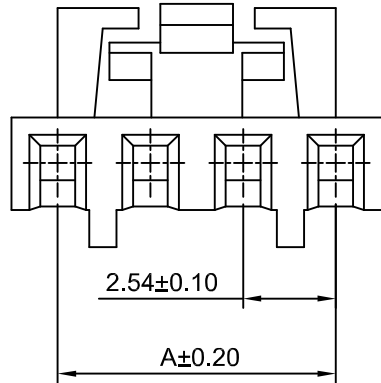

4P~25P

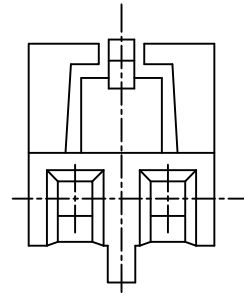

2P

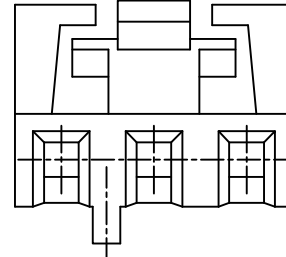

3P

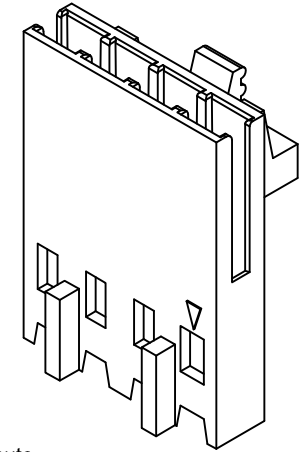

SPECIFICATIONS:

Current Rating: 3A AC,DC
Voltage Rating: 300V AC,DC
Temperature Range: -25°C ~ +85°C
Contact Resistance: 5mΩ Max
Insulation Resistance: 1000MΩ Min
Withstanding Voltage: 1100V AC/minute
Material: PBT30%GF,UL94V-0(Black)

Ordering Information & Dimensions

Circuits	Dimensions(mm)		Circuits	Dimensions(mm)	
	A	B		A	B
2P	2.54	5.08	14P	33.02	35.56
3P	5.08	7.62	15P	35.56	38.10
4P	7.62	10.16	16P	38.10	40.64
5P	10.16	12.70	17P	40.64	43.18
6P	12.70	15.24	18P	43.18	45.72
7P	15.24	17.78	19P	45.72	48.26
8P	17.78	20.32	20P	48.26	50.80
9P	20.32	22.86	21P	50.80	53.34
10P	22.86	25.40	22P	53.34	55.88
11P	25.40	27.94	23P	55.88	58.42
12P	27.94	30.48	24P	58.42	60.96
13P	30.48	33.02	25P	60.96	63.50

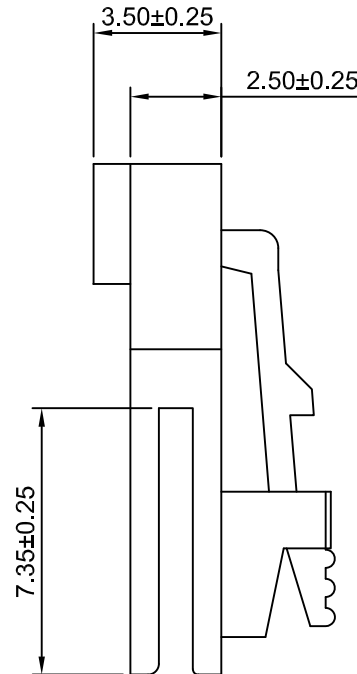
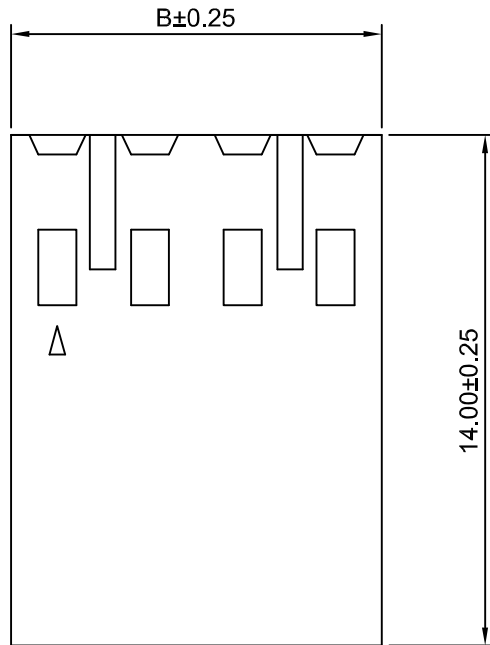

深圳市华德共创科技有限公司

SHENZHEN HUADE CO-CREATE TECHNOLOGY CO.,LTD

TEL : 0755-27129737 FAX : 0755-29940187

-TOLERANCES- UNLESS OTHERWISE SPECIFIED 公差参数表						TITLE: 2.54mm Pitch Housing 产品名称: 2.54mm Pitch Housing			
X.X	±0.30	X.X°	±3°	APPD: 核准:	XIE	PART NO: 产品编号: HDGC2550H-XP-A			
X.XX	±0.30	X.XX°	±2°	CHECK: 校对:	WANG	DATE	SCALE	UNIT	CODE NUMBER
X.XXX	±0.10	X.XXX°	±1°	DRAW: 绘图:	WANG	2012-12-10	5:1	mm	A008

修订 REV	标记 MARK	修改摘要 REVISION DESCRIPTION	签名 SIGNATURE	日期 DATE
AO		NEW RELEASE	WANG	2012-12-10

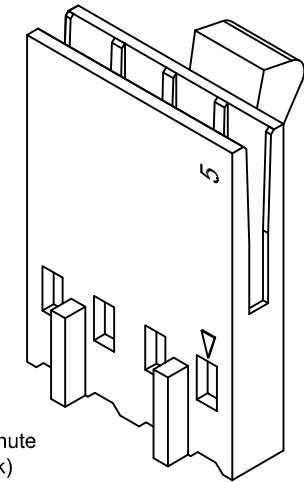
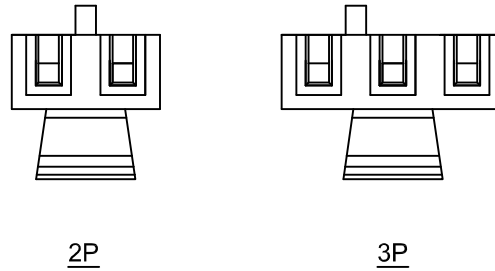
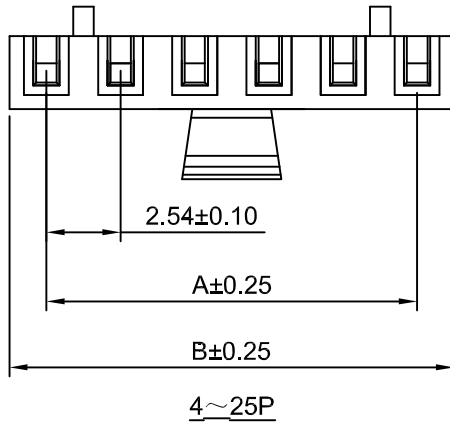

SPECIFICATIONS:

Current Rating: 3A AC,DC
Voltage Rating: 300V AC,DC
Temperature Range: -25°C ~ +85°C
Contact Resistance: 5mΩ Max
Insulation Resistance: 1000MΩ Min
Withstanding Voltage: 1100V AC/minute
Material: PBT30%GF,UL94V-0(Black)

Ordering Information & Dimensions

Circuits	Dimensions(mm)		Circuits	Dimensions(mm)	
	A	B		A	B
2P	2.54	5.08	14P	33.02	35.56
3P	5.08	7.62	15P	35.56	38.10
4P	7.62	10.16	16P	38.10	40.64
5P	10.16	12.70	17P	40.64	43.18
6P	12.70	15.24	18P	43.18	45.72
7P	15.24	17.78	19P	45.72	48.26
8P	17.78	20.32	20P	48.26	50.80
9P	20.32	22.86	21P	50.80	53.34
10P	22.86	25.40	22P	53.34	55.88
11P	25.40	27.94	23P	55.88	58.42
12P	27.94	30.48	24P	58.42	60.96
13P	30.48	33.02	25P	60.96	63.50

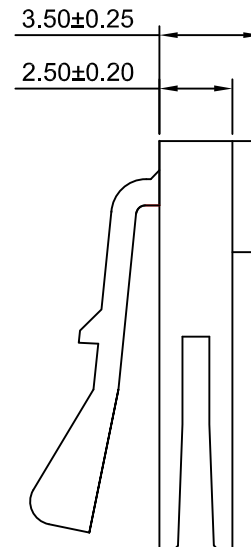
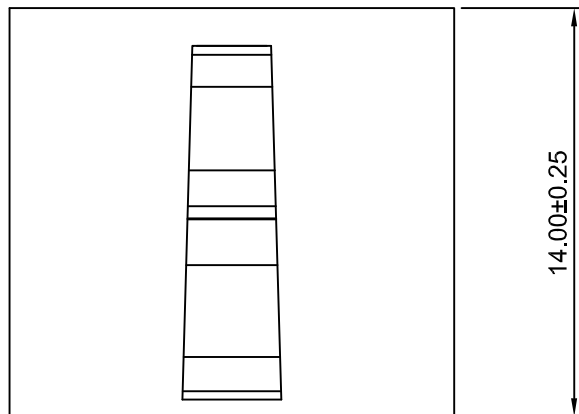

HDGC 深圳市华德共创科技有限公司
SHENZHEN HUADE CO-CREATE TECHNOLOGY CO.,LTD
TEL : 0755-27129737 FAX : 0755-29940187

-TOLERANCES- UNLESS OTHERWISE SPECIFIED 公差参数表						TITLE: 2.54mm Pitch 产品名称: Housing			
X.X	±0.30	X.X°	±3°	APPD: 核准:	XIE	PART NO: 产品编号: HDGC2550H-XP-A1			
X.XX	±0.30	X.XX°	±2°	CHECK: 校对:	WANG	DATE	SCALE	UNIT	CODE NUMBER
X.XXX	±0.10	X.XXX°	±1°	DRAW: 绘图:	WANG	2012-12-10	4:1	mm	A008

修订 REV	标记 MARK	修改摘要 REVISION DESCRIPTION	签名 SIGNATURE	日期 DATE
AO		NEW RELEASE	WANG	2012-12-10

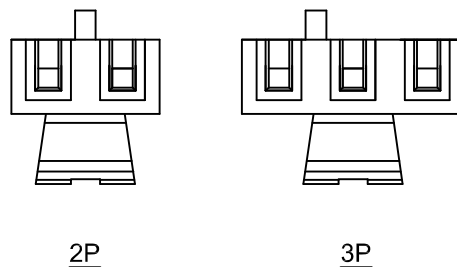
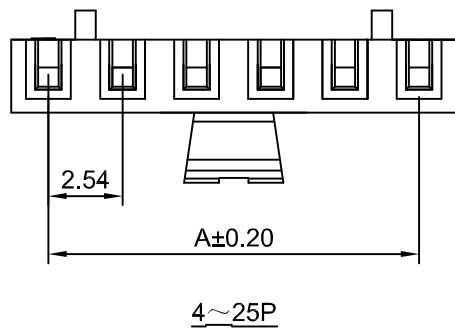

SPECIFICATIONS:
 Current Rating: 3A AC,DC
 Voltage Rating: 300V AC,DC
 Temperature Range: -25°C ~ +85°C
 Contact Resistance: 5mΩ Max
 Insulation Resistance: 1000MΩ Min
 Withstanding Voltage: 1100V AC/minute
 Material: PBT30%GF,UL94V-0(Black)

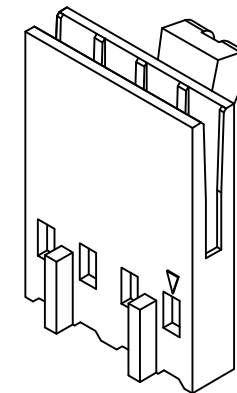

Ordering Information & Dimensions

Circuits	Dimensions(mm)		Circuits	Dimensions(mm)	
	A	B		A	B
2P	2.54	5.08	14P	33.02	35.56
3P	5.08	7.62	15P	35.56	38.10
4P	7.62	10.16	16P	38.10	40.64
5P	10.16	12.70	17P	40.64	43.18
6P	12.70	15.24	18P	43.18	45.72
7P	15.24	17.78	19P	45.72	48.26
8P	17.78	20.32	20P	48.26	50.80
9P	20.32	22.86	21P	50.80	53.34
10P	22.86	25.40	22P	53.34	55.88
11P	25.40	27.94	23P	55.88	58.42
12P	27.94	30.48	24P	58.42	60.96
13P	30.48	33.02	25P	60.96	63.50

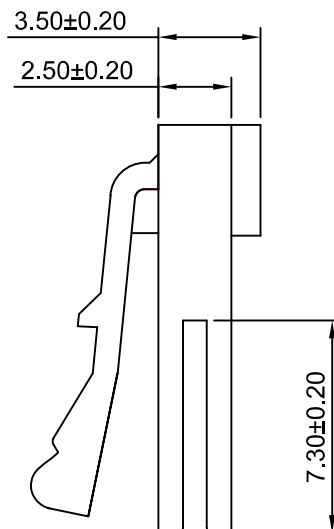
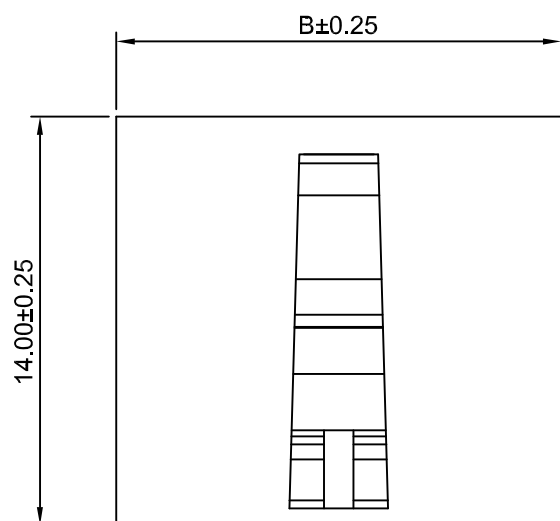

HDGC 深圳市华德共创科技有限公司
 SHENZHEN HUADE CO-CREATE TECHNOLOGY CO.,LTD
 TEL : 0755-27129737 FAX : 0755-29940187

-TOLERANCES- UNLESS OTHERWISE SPECIFIED 公差参数表						TITLE: 2.54mm Pitch Housing 产品名称: 2.54mm Pitch Housing			
X.X	±0.30	X.X°	±3°	APPD: 核准:	XIE	PART NO: 产品编号: HDGC2550H-XP-A2			
X.XX	±0.30	X.XX°	±2°	CHECK: 校对:	WANG	DATE	SCALE	UNIT	CODE NUMBER
X.XXX	±0.10	X.XXX°	±1°	DRAW: 绘图:	WANG	2012-12-10	4:1	mm	A008

修订 REV	标记 MARK	修改摘要 REVISION DESCRIPTION	签名 SIGNATURE	日期 DATE
AO		NEW RELEASE	WANG	2012-12-10

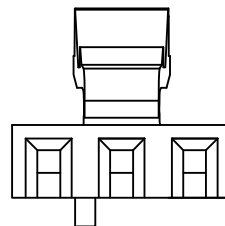
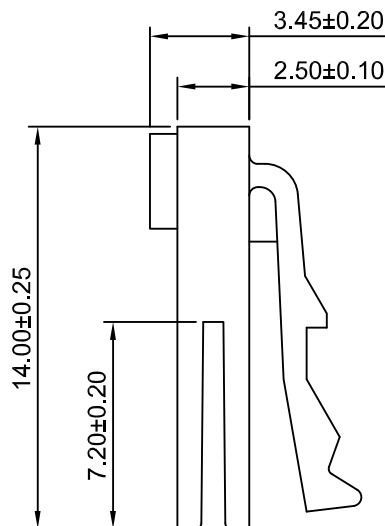
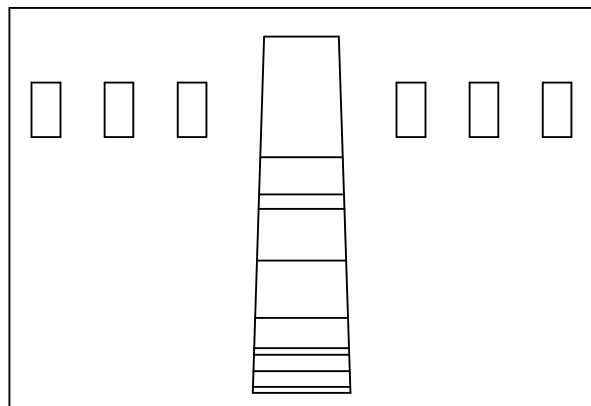
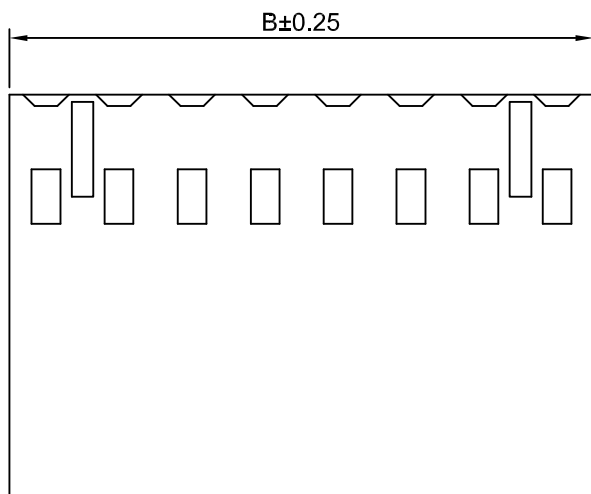
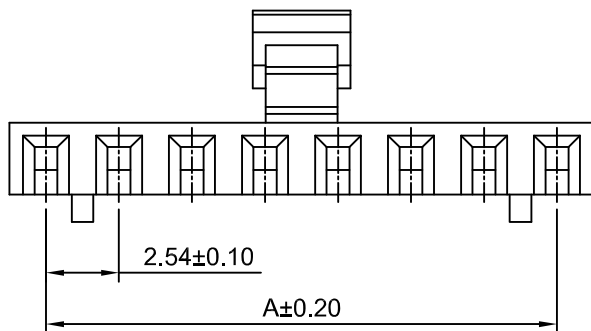

3P

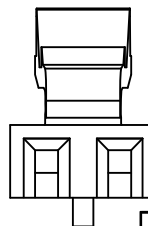

2P

SPECIFICATIONS:

Current Rating: 3A AC,DC
Voltage Rating: 300V AC,DC
Temperature Range: -25°C ~ +85°C
Contact Resistance: 5mΩ Max
Insulation Resistance: 1000MΩ Min
Withstanding Voltage: 1100V AC/minute
Material: PBT30%GF,UL94V-0(Black)

Ordering Information & Dimensions

Circuits	Dimensions(mm)		Circuits	Dimensions(mm)	
	A	B		A	B
2P	2.54	5.08	14P	33.02	35.56
3P	5.08	7.62	15P	35.56	38.10
4P	7.62	10.16	16P	38.10	40.64
5P	10.16	12.70	17P	40.64	43.18
6P	12.70	15.24	18P	43.18	45.72
7P	15.24	17.78	19P	45.72	48.26
8P	17.78	20.32	20P	48.26	50.80
9P	20.32	22.86	21P	50.80	53.34
10P	22.86	25.40	22P	53.34	55.88
11P	25.40	27.94	23P	55.88	58.42
12P	27.94	30.48	24P	58.42	60.96
13P	30.48	33.02	25P	60.96	63.50

HDGC 深圳市华德共创科技有限公司
SHENZHEN HUADE CO-CREATE TECHNOLOGY CO.,LTD
TEL : 0755-27129737 FAX : 0755-29940187

-TOLERANCES- UNLESS OTHERWISE SPECIFIED 公差参数表						TITLE: 2.54mm Pitch Housing 产品名称: 2.54mm Pitch Housing			
X.X	±0.30	X.X°	±3°	APPD: 核准:	XIE	PART NO: 产品编号: HDGC2550H-XP-A2H			
X.XX	±0.30	X.XX°	±2°	CHECK: 校对:	WANG	DATE	SCALE	UNIT	CODE NUMBER
X.XXX	±0.10	X.XXX°	±1°	DRAW: 绘图:	WANG	2012-12-10	4:1	mm	A008

修订 REV	标记 MARK	修改摘要 REVISION DESCRIPTION	签名 SIGNATURE	日期 DATE
AO		NEW RELEASE	WANG	2018-09-10

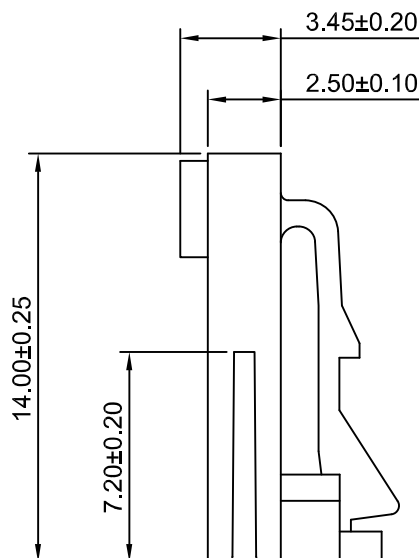
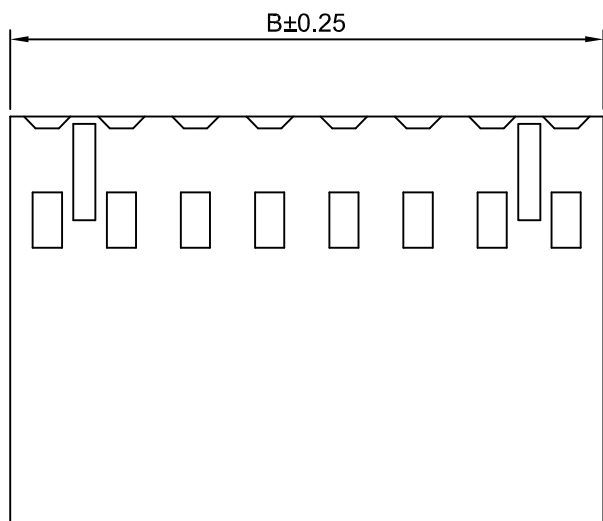
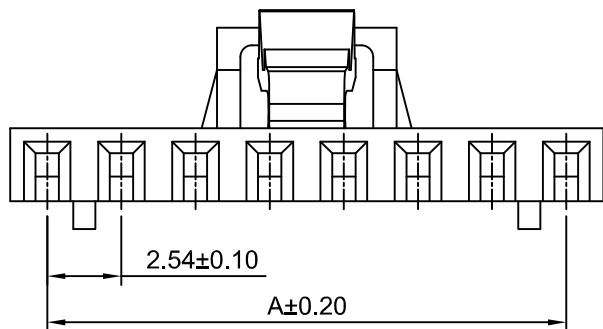

SPECIFICATIONS:

Current Rating: 3A AC,DC
Voltage Rating: 300V AC,DC
Temperature Range: $-25^{\circ}\text{C} \sim +85^{\circ}\text{C}$
Contact Resistance: 5mΩ Max
Insulation Resistance: 1000MΩ Min
Withstanding Voltage: 1100V AC/minute
Material: PBT30%GF,UL94V-0(Black)

Ordering Information & Dimensions

Circuits	Dimensions(mm)		Circuits	Dimensions(mm)	
	A	B		A	B
2P	2.54	5.08	14P	33.02	35.56
3P	5.08	7.62	15P	35.56	38.10
4P	7.62	10.16	16P	38.10	40.64
5P	10.16	12.70	17P	40.64	43.18
6P	12.70	15.24	18P	43.18	45.72
7P	15.24	17.78	19P	45.72	48.26
8P	17.78	20.32	20P	48.26	50.80
9P	20.32	22.86	21P	50.80	53.34
10P	22.86	25.40	22P	53.34	55.88
11P	25.40	27.94	23P	55.88	58.42
12P	27.94	30.48	24P	58.42	60.96
13P	30.48	33.02	25P	60.96	63.50



深圳市华德共创科技有限公司

SHENZHEN HUADE CO-CREATE TECHNOLOGY CO.,LTD

TEL : 0755-27129737 FAX : 0755-29940187

-TOLERANCES- UNLESS OTHERWISE SPECIFIED 公差参数表						TITLE: 2.54mm Pitch 产品名称: Housing			
X.X	±0.30	X.X°	±3°	APPD: 核准:	XIE	PART NO: 产品编号: HDGC2550H-XP-A3			
X.XX	±0.30	X.XX°	±2°	CHECK: 校对:	WANG	DATE	SCALE	UNIT	CODE NUMBER
X.XXX	±0.10	X.XXX°	±1°	DRAW: 绘图:	WANG	2018-09-10	4:1	mm	A008

修订 REV	标记 MARK	修改摘要 REVISION DESCRIPTION	签名 SIGNATURE	日期 DATE
AO		NEW RELEASE	WANG	2018-09-10

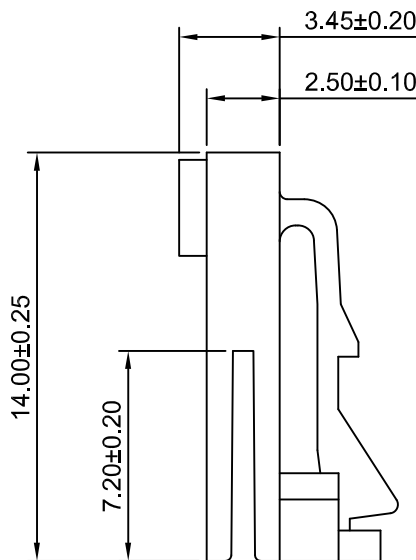
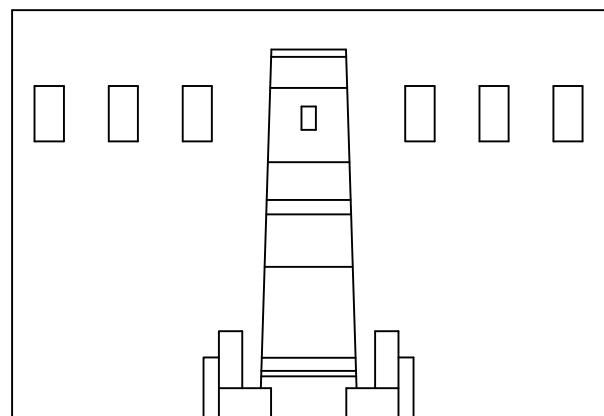
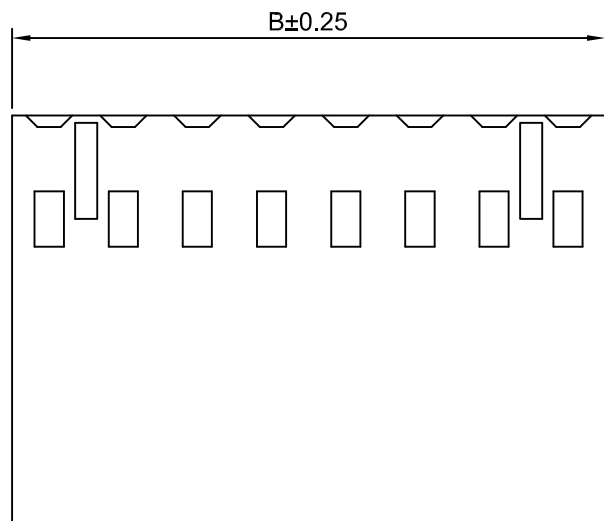
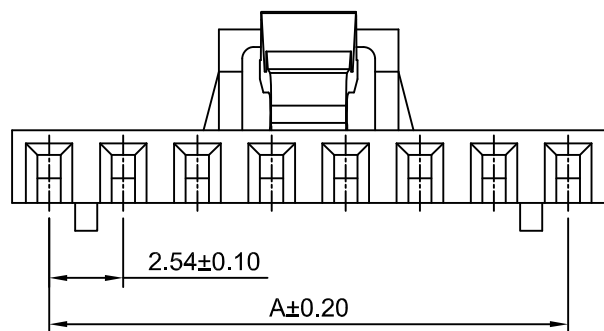

SPECIFICATIONS:

Current Rating: 3A AC,DC
Voltage Rating: 300V AC,DC
Temperature Range: -25°C ~ +85°C
Contact Resistance: 5mΩ Max
Insulation Resistance: 1000MΩ Min
Withstanding Voltage: 1100V AC/minute
Material: PBT30%GF,UL94V-0(Black)

Ordering Information & Dimensions

Circuits	Dimensions(mm)		Circuits	Dimensions(mm)	
	A	B		A	B
2P	2.54	5.08	14P	33.02	35.56
3P	5.08	7.62	15P	35.56	38.10
4P	7.62	10.16	16P	38.10	40.64
5P	10.16	12.70	17P	40.64	43.18
6P	12.70	15.24	18P	43.18	45.72
7P	15.24	17.78	19P	45.72	48.26
8P	17.78	20.32	20P	48.26	50.80
9P	20.32	22.86	21P	50.80	53.34
10P	22.86	25.40	22P	53.34	55.88
11P	25.40	27.94	23P	55.88	58.42
12P	27.94	30.48	24P	58.42	60.96
13P	30.48	33.02	25P	60.96	63.50



深圳市华德共创科技有限公司

SHENZHEN HUADE CO-CREATE TECHNOLOGY CO.,LTD

TEL : 0755-27129737 FAX : 0755-29940187

-TOLERANCES- UNLESS OTHERWISE SPECIFIED 公差参数表						TITLE: 2.54mm Pitch 产品名称: Housing			
X.X	±0.30	X.X°	±3°	APPD: 核准:	XIE	PART NO: 产品编号: HDGC2550H-XP-A3H			
X.XX	±0.30	X.XX°	±2°	CHECK: 校对:	WANG	DATE	SCALE	UNIT	CODE NUMBER
X.XXX	±0.10	X.XXX°	±1°	DRAW: 绘图:	WANG	2018-09-10	4:1	mm	A008

修订 REV	标记 MARK	修改摘要 REVISION DESCRIPTION	签名 SIGNATURE	日期 DATE
AO		NEW RELEASE	WANG	2012-12-10

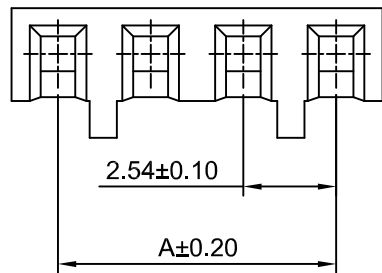

4P~25P

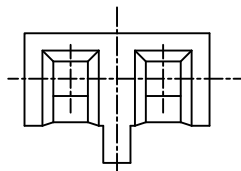

2P

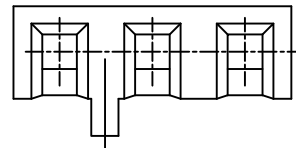

3P

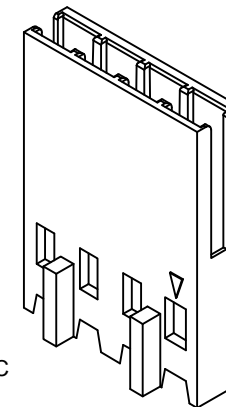

SPECIFICATIONS:

Current Rating: 3A AC,DC
Voltage Rating: 300V AC,DC
Temperature Range: -25°C ~ +85°C
Contact Resistance: 5mΩ Max
Insulation Resistance: 1000MΩ Min
Withstanding Voltage: 1100V AC/minute
Material: PBT30%GF,UL94V-0(Black)

Ordering Information & Dimensions

Circuits	Dimensions(mm)		Circuits	Dimensions(mm)	
	A	B		A	B
2P	2.54	5.08	14P	33.02	35.56
3P	5.08	7.62	15P	35.56	38.10
4P	7.62	10.16	16P	38.10	40.64
5P	10.16	12.70	17P	40.64	43.18
6P	12.70	15.24	18P	43.18	45.72
7P	15.24	17.78	19P	45.72	48.26
8P	17.78	20.32	20P	48.26	50.80
9P	20.32	22.86	21P	50.80	53.34
10P	22.86	25.40	22P	53.34	55.88
11P	25.40	27.94	23P	55.88	58.42
12P	27.94	30.48	24P	58.42	60.96
13P	30.48	33.02	25P	60.96	63.50

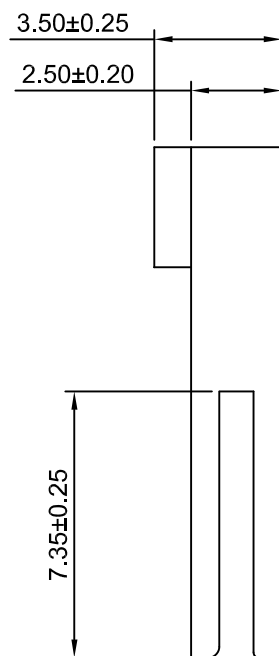
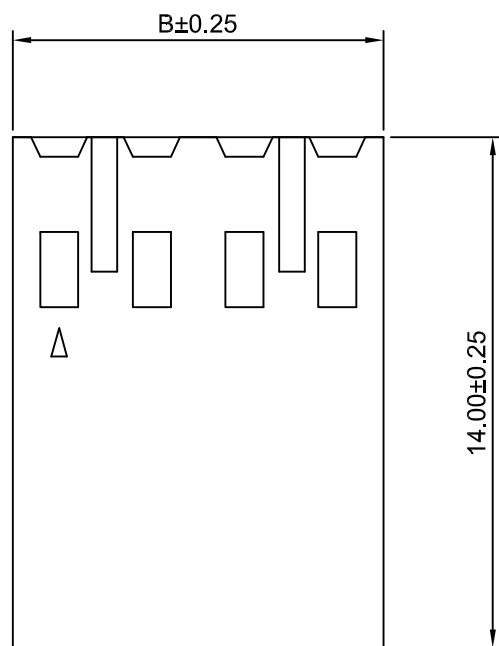

HDGC 深圳市华德共创科技有限公司
SHENZHEN HUADE CO-CREATE TECHNOLOGY CO.,LTD
TEL : 0755-27129737 FAX : 0755-29940187

-TOLERANCES- UNLESS OTHERWISE SPECIFIED 公差参数表				 TITLE: 2.54mm Pitch 产品名称: Housi ng				
X.X	±0.30	X.X°	±3°	APPD: 核准: XIE	PART NO: 产品编号: HDGC2550H-XP-B			
X.XX	±0.30	X.XX°	±2°	CHECK: 校对: WANG	DATE	SCALE	UNIT	CODE NUMBER
X.XXX	±0.10	X.XXX°	±1°	DRAW: 绘图: WANG	2012-12-10	5:1	mm	A008

修订 REV	标记 MARK	修改摘要 REVISION DESCRIPTION	签名 SIGNATURE	日期 DATE
AO		NEW RELEASE	WANG	2012-12-10

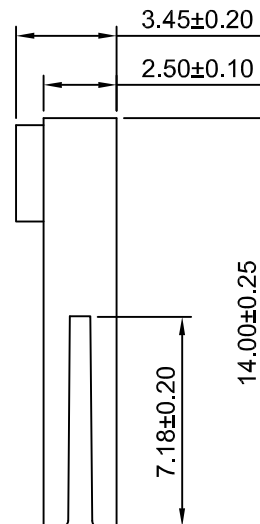
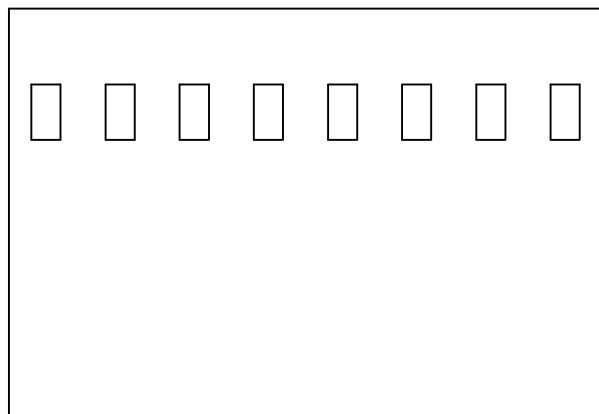
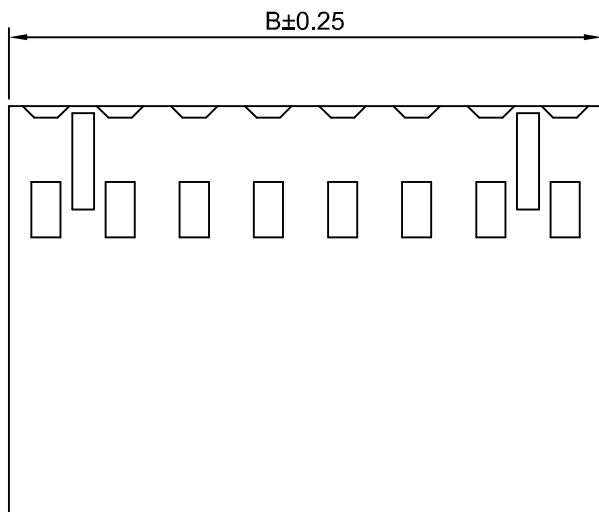
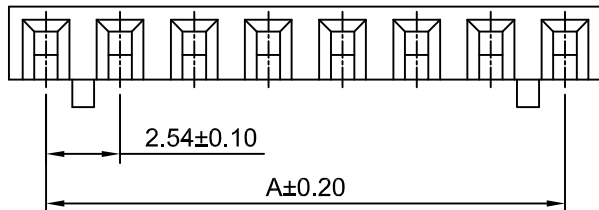

SPECIFICATIONS:

Current Rating: 3A AC,DC
Voltage Rating: 300V AC,DC
Temperature Range: -25°C ~ +85°C
Contact Resistance: 5mΩ Max
Insulation Resistance: 1000MΩ Min
Withstanding Voltage: 1100V AC/minute
Material: PBT30%GF,UL94V-0(Black)

Ordering Information & Dimensions

Circuits	Dimensions(mm)		Circuits	Dimensions(mm)	
	A	B		A	B
2P	2.54	5.08	14P	33.02	35.56
3P	5.08	7.62	15P	35.56	38.10
4P	7.62	10.16	16P	38.10	40.64
5P	10.16	12.70	17P	40.64	43.18
6P	12.70	15.24	18P	43.18	45.72
7P	15.24	17.78	19P	45.72	48.26
8P	17.78	20.32	20P	48.26	50.80
9P	20.32	22.86	21P	50.80	53.34
10P	22.86	25.40	22P	53.34	55.88
11P	25.40	27.94	23P	55.88	58.42
12P	27.94	30.48	24P	58.42	60.96
13P	30.48	33.02	25P	60.96	63.50



深圳市华德共创科技有限公司

SHENZHEN HUADE CO-CREATE TECHNOLOGY CO.,LTD

TEL : 0755-27129737 FAX : 0755-29940187

-TOLERANCES- UNLESS OTHERWISE SPECIFIED 公差参数表						TITLE: 2.54mm Pitch Housing 产品名称:			
X.X	±0.30	X.X°	±3°	APPD: 核准:	XIE	PART NO: 产品编号: HDGC2550H-XP-BH			
X.XX	±0.30	X.XX°	±2°	CHECK: 校对:	WANG	DATE	SCALE	UNIT	CODE NUMBER
X.XXX	±0.10	X.XXX°	±1°	DRAW: 绘图:	WANG	2012-12-10	4:1	mm	A008

修订 REV	标记 MARK	修改摘要 REVISION DESCRIPTION	签名 SIGNATURE	日期 DATE
AO		NEW RELEASE	WANG	2012-12-10

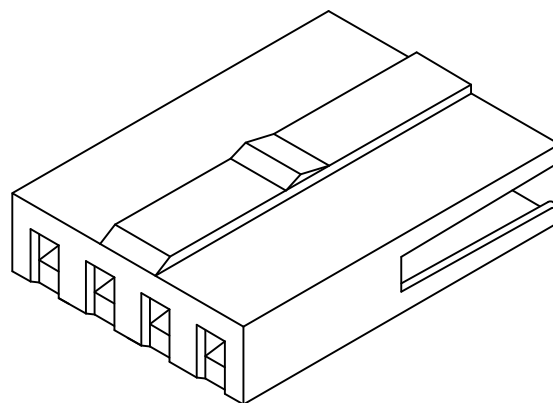
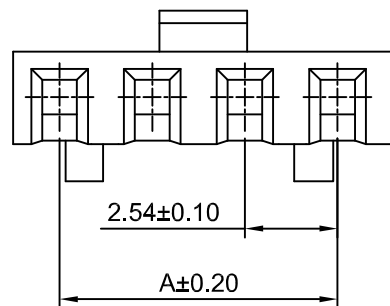

SPECIFICATIONS:

Current Rating: 3A AC,DC
Voltage Rating: 300V AC,DC
Temperature Range: -25°C ~ +85°C
Contact Resistance: 5mΩ Max
Insulation Resistance: 1000MΩ Min
Withstanding Voltage: 1100V AC/minute
Material: PBT30%GF,UL94V-0(Black)

Ordering Information & Dimensions

Circuits	Dimensions(mm)		Circuits	Dimensions(mm)	
	A	B		A	B
2P	2.54	5.08	14P	33.02	35.56
3P	5.08	7.62	15P	35.56	38.10
4P	7.62	10.16	16P	38.10	40.64
5P	10.16	12.70	17P	40.64	43.18
6P	12.70	15.24	18P	43.18	45.72
7P	15.24	17.78	19P	45.72	48.26
8P	17.78	20.32	20P	48.26	50.80
9P	20.32	22.86	21P	50.80	53.34
10P	22.86	25.40	22P	53.34	55.88
11P	25.40	27.94	23P	55.88	58.42
12P	27.94	30.48	24P	58.42	60.96
13P	30.48	33.02	25P	60.96	63.50

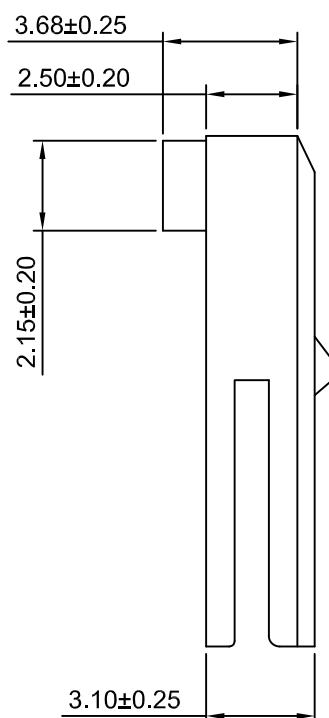
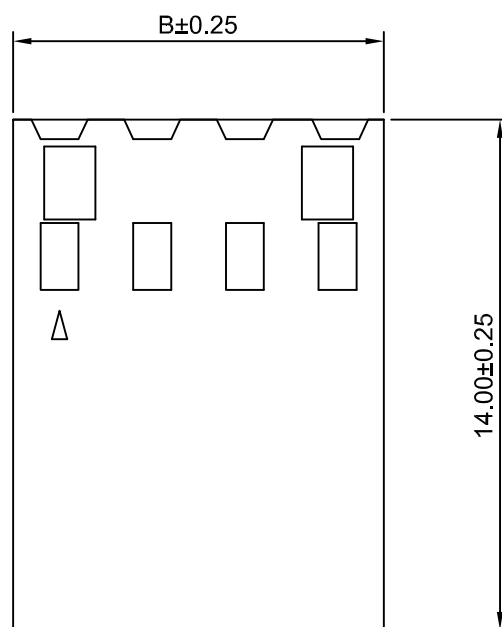

深圳市华德共创科技有限公司
SHENZHEN HUADE CO-CREATE TECHNOLOGY CO.,LTD
TEL : 0755-27129737 FAX : 0755-29940187

-TOLERANCES- UNLESS OTHERWISE SPECIFIED 公差参数表				TITLE: 2.54mm Pitch Housing 产品名称: 2.54mm Pitch Housing				
X.X	±0.30	X.X°	±3°	APPD: 核准:	XIE			
X.XX	±0.30	X.XX°	±2°	CHECK: 校对:	WANG			
X.XXX	±0.10	X.XXX°	±1°	DRAW: 绘图:	WANG			
				PART NO: 产品编号:	HDGC2550H-XP-C			
				DATE	SCALE	UNIT	CODE NUMBER	
				2012-12-10	5:1	mm	A008	

修订 REV	标记 MARK	修改摘要 REVISION DESCRIPTION	签名 SIGNATURE	日期 DATE
AO		NEW RELEASE	WANG	2012-12-10

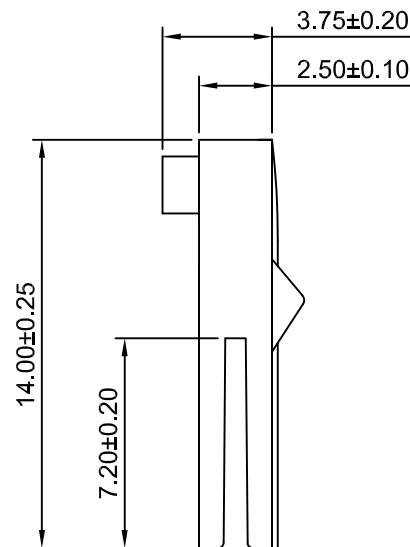
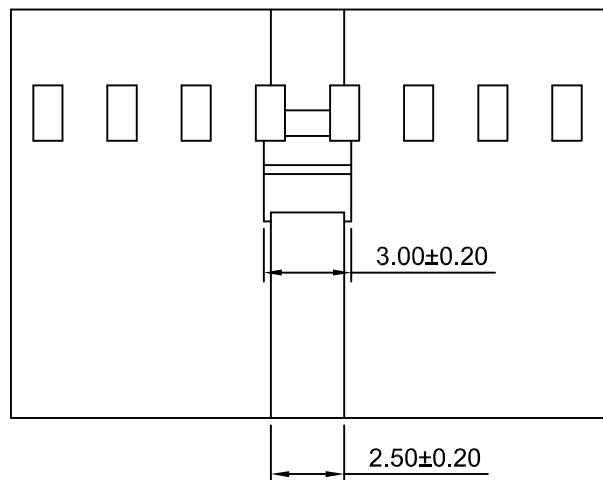
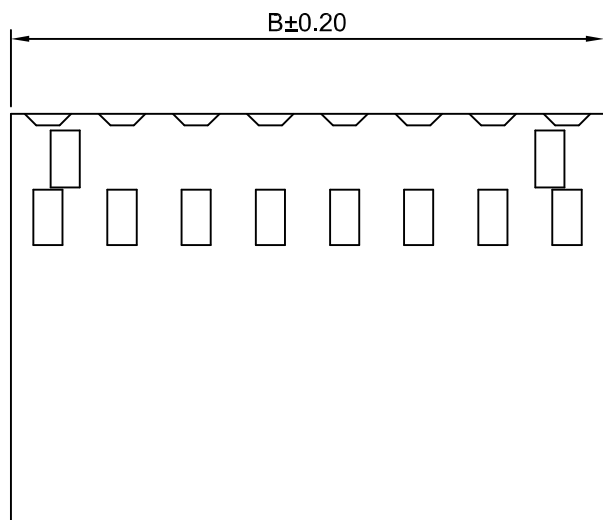
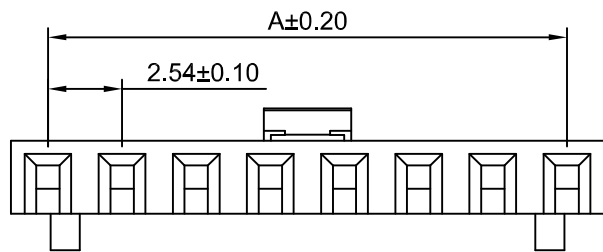

SPECIFICATIONS:

Current Rating: 3A AC,DC
Voltage Rating: 250V AC,DC
Temperature Range: $-25^{\circ}\text{C} \sim +85^{\circ}\text{C}$
Contact Resistance: 20m Ω Max
Insulation Resistance: 1000M Ω Min
Withstanding Voltage: 1500V AC/minute
Material: PBT,UL94V-0(Black)

Ordering Information & Dimensions

Circuits	Dimensions(mm)		Circuits	Dimensions(mm)	
	A	B		A	B
2P	2.54	5.08	14P	33.02	35.56
3P	5.08	7.62	15P	35.56	38.10
4P	7.62	10.16	16P	38.10	40.64
5P	10.16	12.70	17P	40.64	43.18
6P	12.70	15.24	18P	43.18	45.72
7P	15.24	17.78	19P	45.72	48.26
8P	17.78	20.32	20P	48.26	50.80
9P	20.32	22.86	21P	50.80	53.34
10P	22.86	25.40	22P	53.34	55.88
11P	25.40	27.94	23P	55.88	58.42
12P	27.94	30.48	24P	58.42	60.96
13P	30.48	33.02	25P	60.96	63.50



深圳市华德共创科技有限公司

SHENZHEN HUADE CO-CREATE TECHNOLOGY CO.,LTD

TEL : 0755-27129737 FAX : 0755-29940187

-TOLERANCES- UNLESS OTHERWISE SPECIFIED 公差参数表						TITLE: 2.54mm Pitch Housing 产品名称:			
X.X	± 0.30	X.X°	$\pm 3^{\circ}$	APPD: 核准:	XIE	PART NO: 产品编号: HDGC2550H-XP-CH			
X.XX	± 0.30	X.XX°	$\pm 2^{\circ}$	CHECK: 校对:	WANG	DATE	SCALE	UNIT	CODE NUMBER
X.XXX	± 0.10	X.XXX°	$\pm 1^{\circ}$	DRAW: 绘图:	WANG	2012-12-10	4:1	mm	A008

修订 REV	标记 MARK	修改摘要 REVISION DESCRIPTION	签名 SIGNATURE	日期 DATE
AO		NEW RELEASE	WANG	2012-12-10

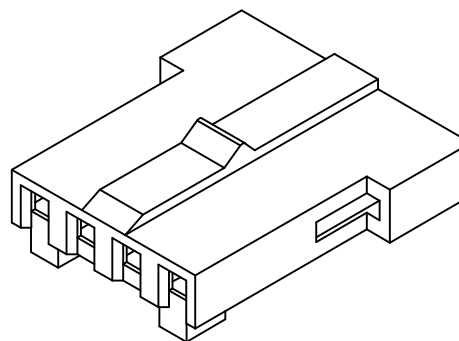
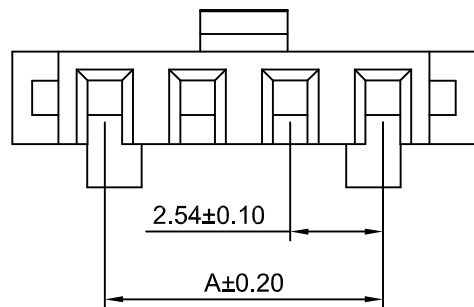

SPECIFICATIONS:

Current Rating: 3A AC,DC
Voltage Rating: 300V AC,DC
Temperature Range: -25°C ~ +85°C
Contact Resistance: 5mΩ Max
Insulation Resistance: 1000MΩ Min
Withstanding Voltage: 1100V AC/minute
Material: PBT30%GF,UL94V-0(Black)

Ordering Information & Dimensions

Circuits	Dimensions(mm)			Circuits	Dimensions(mm)		
	A	B	C		A	B	C
2P	2.54	5.08	7.62	14P	33.02	35.56	38.10
3P	5.08	7.62	10.16	15P	35.56	38.10	40.64
4P	7.62	10.16	12.70	16P	38.10	40.64	43.18
5P	10.16	12.70	15.24	17P	40.64	43.18	45.72
6P	12.70	15.24	17.78	18P	43.18	45.72	48.26
7P	15.24	17.78	20.32	19P	45.72	48.26	50.80
8P	17.78	20.32	22.86	20P	48.26	50.80	53.34
9P	20.32	22.86	25.40	21P	50.80	53.34	55.88
10P	22.86	25.40	27.94	22P	53.34	55.88	58.42
11P	25.40	27.94	30.48	23P	55.88	58.42	60.96
12P	27.94	30.48	33.02	24P	58.42	60.96	63.50
13P	30.48	33.02	35.56	25P	60.96	63.50	66.04

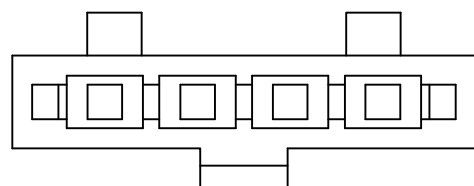
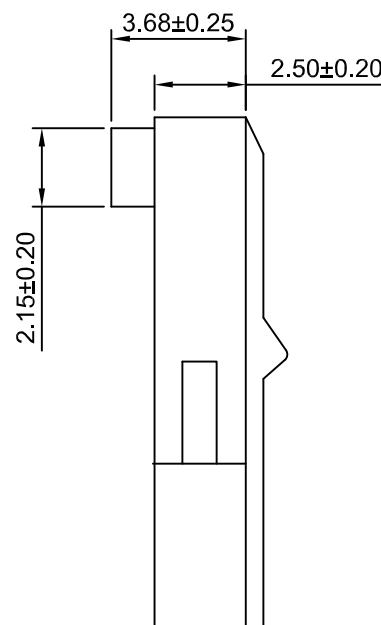
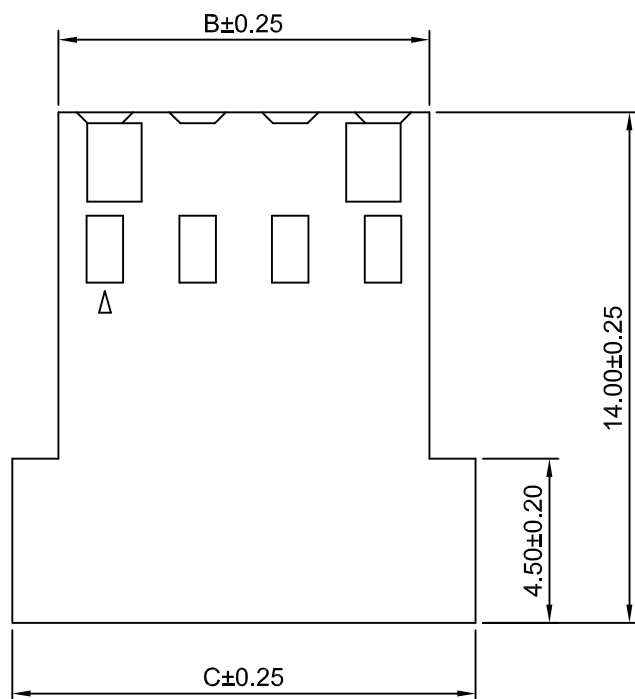



深圳市华德共创科技有限公司

SHENZHEN HUADE CO-CREATE TECHNOLOGY CO.,LTD

TEL : 0755-27129737 FAX : 0755-29940187

-TOLERANCES- UNLESS OTHERWISE SPECIFIED 公差参数表				 	TITLE: 2.54mm Pitch Housing 产品名称: 2.54mm Pitch Housing			
X.X	±0.30	X.X°	±3°	APPD: 核准:	XIE			
X.XX	±0.30	X.XX°	±2°	CHECK: 校对:	WANG			
X.XXX	±0.10	X.XXX°	±1°	DRAW: 绘图:	WANG			
PART NO: 产品编号:					HDGC2550H-XP-C1			
		DATE	SCALE	UNIT	CODE NUMBER			
		2012-12-10	5:1	mm	A008			

修订 REV	标记 MARK	修改摘要 REVISION DESCRIPTION	签名 SIGNATURE	日期 DATE
AO		NEW RELEASE	WANG	2012-12-10

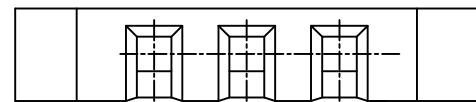

2.54±0.10

A±0.20

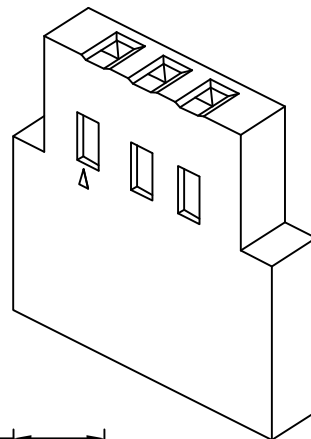

SPECIFICATIONS:

Current Rating: 3A AC,DC
Voltage Rating: 300V AC,DC
Temperature Range: -25°C ~ +85°C
Contact Resistance: 5mΩ Max
Insulation Resistance: 1000MΩ Min
Withstanding Voltage: 1100V AC/minute
Material: PBT30%GF,UL94V-0(Blue)

Ordering Information & Dimensions

Circuits	Dimensions(mm)			Circuits	Dimensions(mm)		
	A	B	C		A	B	C
2P	2.54	6.81	9.86	14P	33.02	37.29	40.34
3P	5.08	9.35	12.40	15P	35.56	39.83	42.88
4P	7.62	11.89	14.94	16P	38.10	42.37	45.42
5P	10.16	14.43	17.48	17P	40.64	44.91	47.96
6P	12.70	16.97	20.02	18P	43.18	47.45	50.50
7P	15.24	19.51	22.56	19P	45.72	49.99	53.04
8P	17.78	22.05	25.10	20P	48.26	52.53	55.58
9P	20.32	24.59	27.64	21P	50.80	55.07	58.12
10P	22.86	27.13	30.18	22P	53.34	57.61	60.66
11P	25.40	29.67	32.72	23P	55.88	60.15	63.20
12P	27.94	32.21	35.26	24P	58.42	62.69	65.74
13P	30.48	34.75	37.80	25P	60.96	65.23	68.28

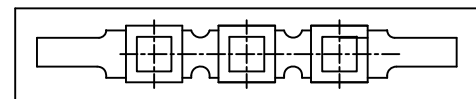
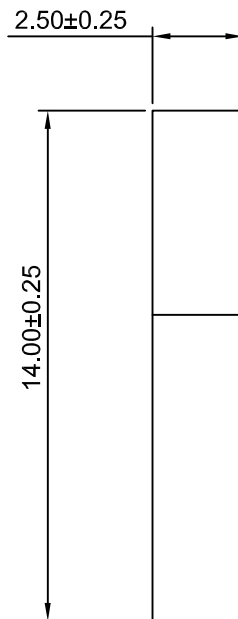
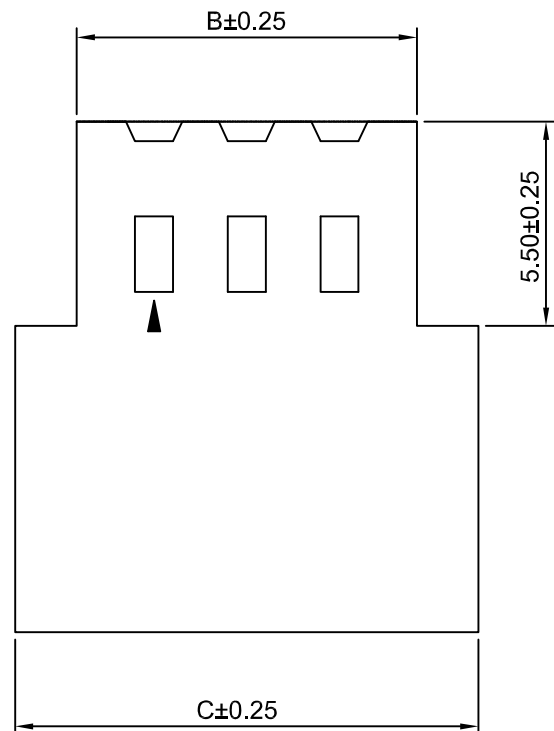

深圳市华德共创科技有限公司
SHENZHEN HUADE CO-CREATE TECHNOLOGY CO.,LTD
TEL : 0755-27129737 FAX : 0755-29940187

-TOLERANCES- UNLESS OTHERWISE SPECIFIED 公差参数表				TITLE: 2.54mm Pitch Housing 产品名称: 2.54mm Pitch Housing			
X.X	±0.30	X.X° ±3°	APPD: 核准: XIE	PART NO: HDGC2550H-XP-D 产品编号:			
X.XX	±0.30	X.XX° ±2°	CHECK: 校对: WANG	DATE	SCALE	UNIT	CODE NUMBER
X.XXX	±0.10	X.XXX° ±1°	DRAW: 绘图: WANG	2012-12-10	5:1	mm	A008

修订 REV	标记 MARK	修改摘要 REVISION DESCRIPTION	签名 SIGNATURE	日期 DATE
AO		NEW RELEASE	WANG	2012-12-10

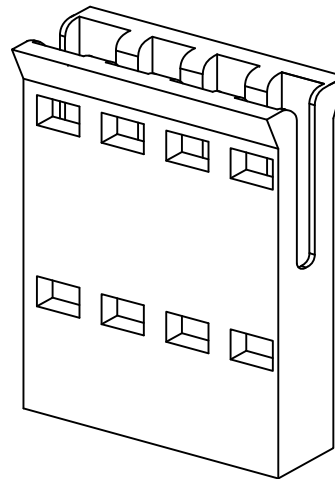
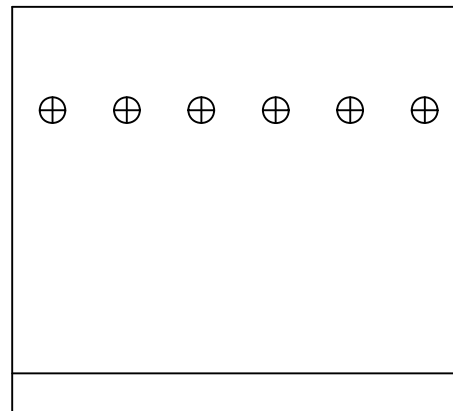
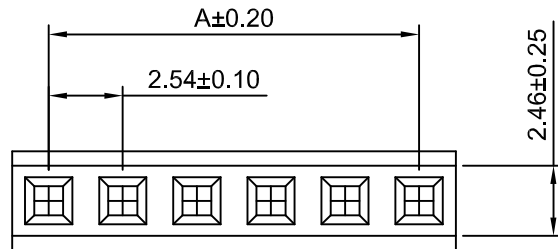
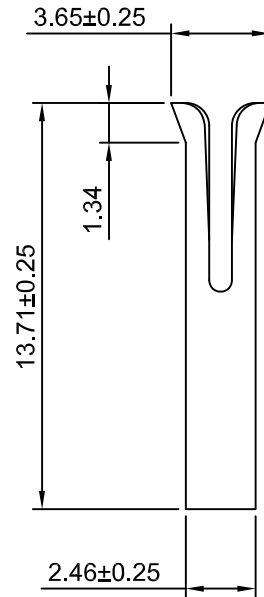
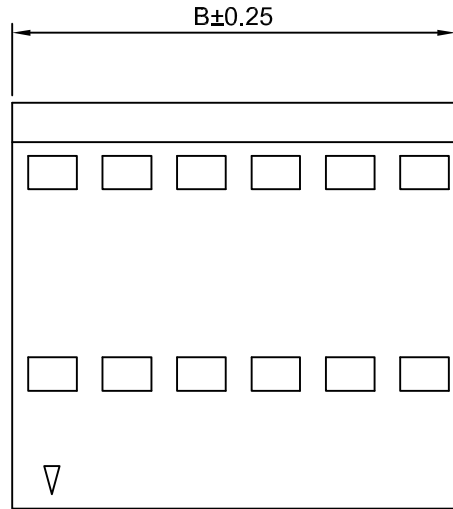

SPECIFICATIONS:

Current Rating: 3A AC,DC
Voltage Rating: 300V AC,DC
Temperature Range: -25°C ~ +85°C
Contact Resistance: 5mΩ Max
Insulation Resistance: 1000MΩ Min
Withstanding Voltage: 1100V AC/minute
Material: PBT30%GF,UL94V-0(Black)

Ordering Information & Dimensions

Circuits	Dimensions(mm)		Circuits	Dimensions(mm)	
	A	B		A	B
2P	2.54	4.92	20P	48.26	50.64
3P	5.08	7.46	21P	50.80	53.18
4P	7.62	10.00	22P	53.34	55.72
5P	10.16	12.54	23P	55.88	58.26
6P	12.70	15.08	24P	58.42	60.80
7P	15.24	17.62	25P	60.96	63.34
8P	17.78	20.16	26P	63.50	65.88
9P	20.32	22.70	27P	66.04	68.42
10P	22.86	25.24	28P	68.58	70.96
11P	25.40	27.78	29P	71.12	73.50
12P	27.94	30.32	30P	73.66	76.04
13P	30.48	32.86	31P	76.20	78.58
14P	33.02	35.40	32P	78.74	81.12
15P	35.56	37.94	33P	81.28	83.66
16P	38.10	40.48	34P	83.82	86.20
17P	40.64	43.02	35P	86.36	88.74
18P	43.18	45.56	36P	88.90	91.28
19P	45.72	48.10			



深圳市华德共创科技有限公司

SHENZHEN HUADE CO-CREATE TECHNOLOGY CO.,LTD

TEL : 0755-27129737 FAX : 0755-29940187

-TOLERANCES- UNLESS OTHERWISE SPECIFIED 公差参数表						TITLE: 产品名称: 2.54mm Pitch Housing			
X.X	±0.30	X.X°	±3°	APPD: 核准:	XIE	PART NO: 产品编号: HDGC2550H-XP-G			
X.XX	±0.30	X.XX°	±2°	CHECK: 校对:	WANG	DATE	SCALE	UNIT	CODE NUMBER
X.XXX	±0.10	X.XXX°	±1°	DRAW: 绘图:	WANG	2012-12-10	4:1	mm	A008

修订 REV	标记 MARK	修改摘要 REVISION DESCRIPTION	签名 SIGNATURE	日期 DATE
AO		NEW RELEASE	WANG	2012-12-10

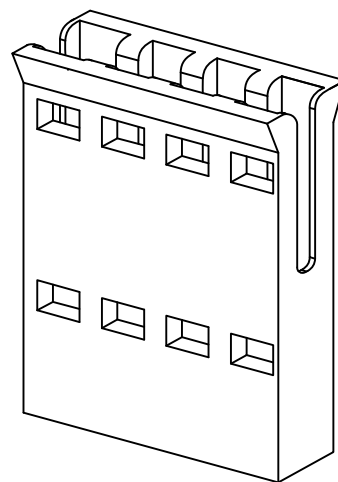
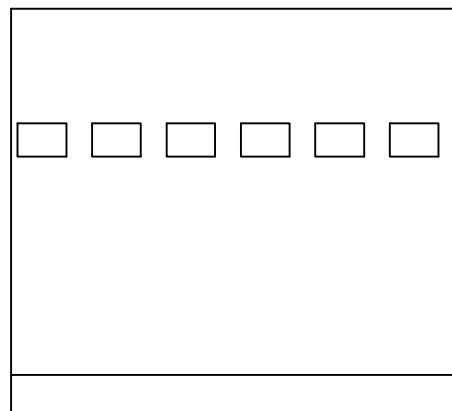
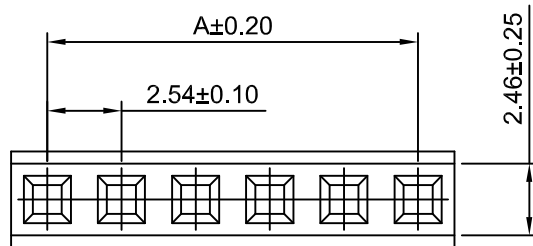
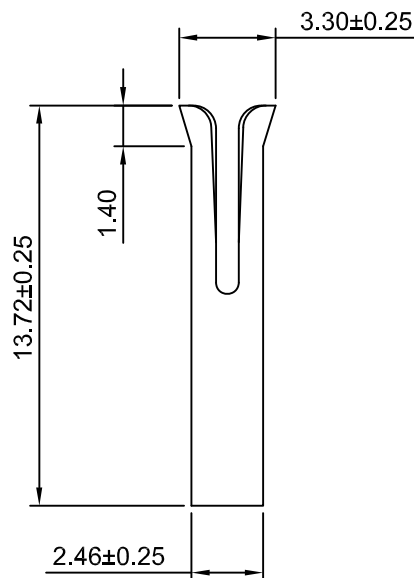
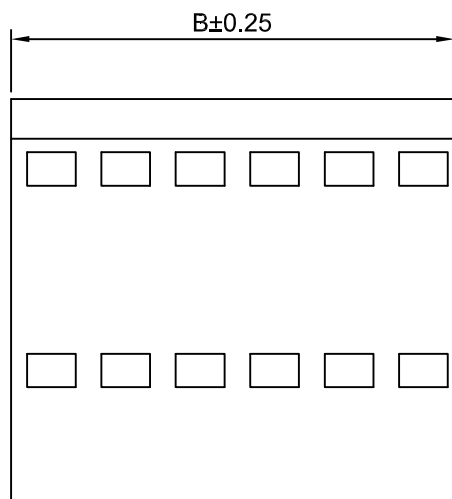

SPECIFICATIONS:

Current Rating: 3A AC,DC
Voltage Rating: 300V AC,DC
Temperature Range: -25°C ~ +85°C
Contact Resistance: 5mΩ Max
Insulation Resistance: 1000MΩ Min
Withstanding Voltage: 1100V AC/minute
Material: PBT30%GF,UL94V-0(Black)

Ordering Information & Dimensions

Circuits	Dimensions(mm)		Circuits	Dimensions(mm)	
	A	B		A	B
2P	2.54	4.92	20P	48.26	50.64
3P	5.08	7.46	21P	50.80	53.18
4P	7.62	10.00	22P	53.34	55.72
5P	10.16	12.54	23P	55.88	58.26
6P	12.70	15.08	24P	58.42	60.80
7P	15.24	17.62	25P	60.96	63.34
8P	17.78	20.16	26P	63.50	65.88
9P	20.32	22.70	27P	66.04	68.42
10P	22.86	25.24	28P	68.58	70.96
11P	25.40	27.78	29P	71.12	73.50
12P	27.94	30.32	30P	73.66	76.04
13P	30.48	32.86	31P	76.20	78.58
14P	33.02	35.40	32P	78.74	81.12
15P	35.56	37.94	33P	81.28	83.66
16P	38.10	40.48	34P	83.82	86.20
17P	40.64	43.02	35P	86.36	88.74
18P	43.18	45.56	36P	88.90	91.28
19P	45.72	48.10			

HDGC 深圳市华德共创科技有限公司
SHENZHEN HUADE CO-CREATE TECHNOLOGY CO.,LTD
TEL : 0755-27129737 FAX : 0755-29940187

-TOLERANCES- UNLESS OTHERWISE SPECIFIED 公差参数表					TITLE: 2.54mm Pitch 产品名称: Housing			
X.X	±0.30	X.X° ±3°	APPD: 核准:	XIE	PART NO: 产品编号: HDGC2550H-XP-G1			
X.XX	±0.30	X.XX° ±2°	CHECK: 校对:	WANG	DATE	SCALE	UNIT	CODE NUMBER
X.XXX	±0.10	X.XXX° ±1°	DRAW: 绘图:	WANG	2012-12-10	4:1	mm	A008

修订 REV	标记 MARK	修改摘要 REVISION DESCRIPTION	签名 SIGNATURE	日期 DATE
AO		NEW RELEASE	WANG	2012-12-10

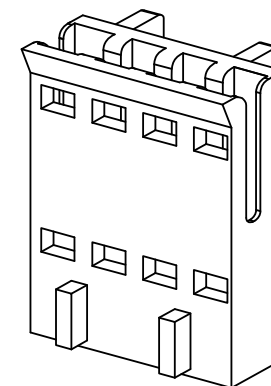
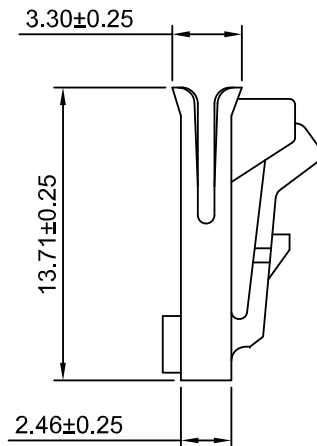
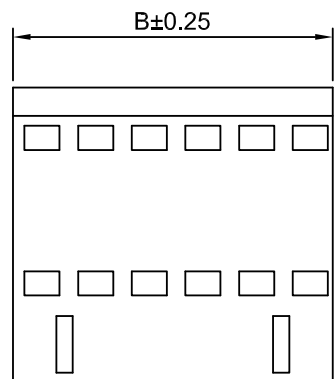

SPECIFICATIONS:

Current Rating: 3A AC,DC
Voltage Rating: 300V AC,DC
Temperature Range: -25°C ~ +85°C
Contact Resistance: 5mΩ Max
Insulation Resistance: 1000MΩ Min
Withstanding Voltage: 1100V AC/minute
Material: PBT30%GF,UL94V-0(Black)

Ordering Information & Dimensions

Circuits	Dimensions(mm)		Circuits	Dimensions(mm)	
	A	B		A	B
2P	2.54	4.92	14P	33.02	35.40
3P	5.08	7.46	15P	35.56	37.94
4P	7.62	10.00	16P	38.10	40.48
5P	10.16	12.54	17P	40.64	43.02
6P	12.70	15.08	18P	43.18	45.56
7P	15.24	17.62	19P	45.72	48.10
8P	17.78	20.16	20P	48.26	50.64
9P	20.32	22.70	21P	50.80	53.18
10P	22.86	25.24	22P	53.34	55.72
11P	25.40	27.78	23P	55.88	58.26
12P	27.94	30.32	24P	58.42	60.80
13P	30.48	32.86	25P	60.96	63.34

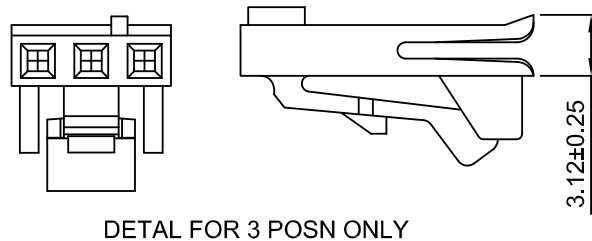
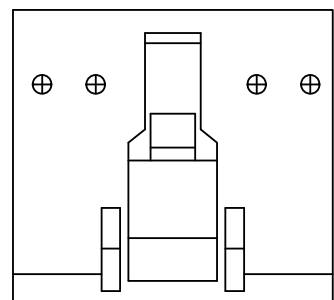
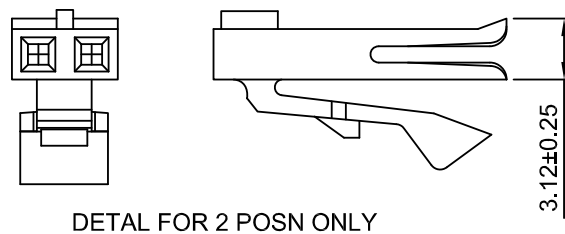
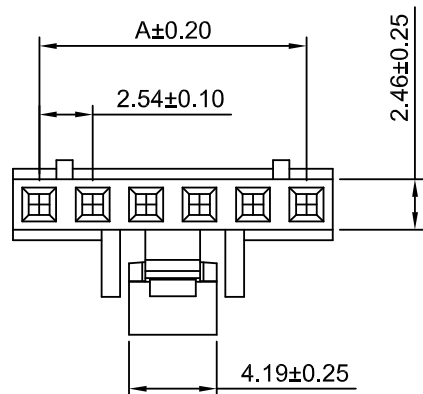

HDGC 深圳市华德共创科技有限公司
SHENZHEN HUADE CO-CREATE TECHNOLOGY CO.,LTD
TEL : 0755-27129737 FAX : 0755-29940187

-TOLERANCES- UNLESS OTHERWISE SPECIFIED 公差参数表				TITLE: 产品名称: 2.54mm Pitch Housing	
X.X	±0.30	X.X°	±3°	APPD: 核准:	XIE
X.XX	±0.30	X.XX°	±2°	CHECK: 校对:	WANG
X.XXX	±0.10	X.XXX°	±1°	DRAW: 绘图:	WANG
PART NO: 产品编号:		HDGC2550H-XP-H			
DATE	SCALE	UNIT	CODE NUMBER		
2012-12-10	3:1	mm	A008		

修订 REV	标记 MARK	修改摘要 REVISION DESCRIPTION	签名 SIGNATURE	日期 DATE
AO		NEW RELEASE	WANG	2012-12-10

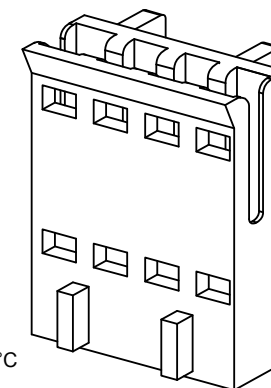
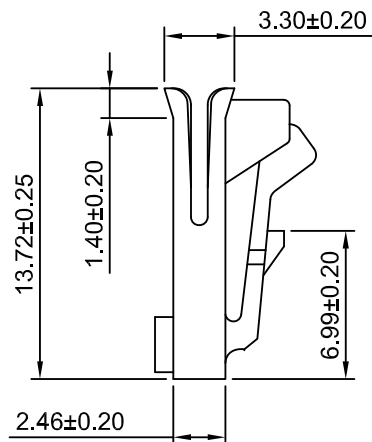
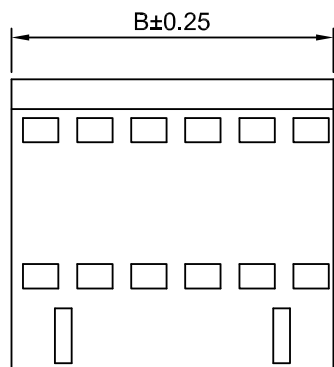

SPECIFICATIONS:

Current Rating: 3A AC,DC
Voltage Rating: 300V AC,DC
Temperature Range: -25°C ~ +85°C
Contact Resistance: 5mΩ Max
Insulation Resistance: 1000MΩ Min
Withstanding Voltage: 1100V AC/minute
Material: PBT30%GF,UL94V-0(Black)

Ordering Information & Dimensions

Circuits	Dimensions(mm)		Circuits	Dimensions(mm)	
	A	B		A	B
2P	2.54	4.92	14P	33.02	35.40
3P	5.08	7.46	15P	35.56	38.94
4P	7.62	10.00	16P	38.10	40.48
5P	10.16	12.54	17P	40.64	43.02
6P	12.70	15.08	18P	43.18	45.56
7P	15.24	17.62	19P	45.72	48.10
8P	17.78	20.16	20P	48.26	50.64
9P	20.32	22.70	21P	50.80	53.18
10P	22.86	25.24	22P	53.34	55.72
11P	25.40	27.78	23P	55.88	58.26
12P	27.94	30.32	24P	58.42	60.80
13P	30.48	32.86	25P	60.96	63.34

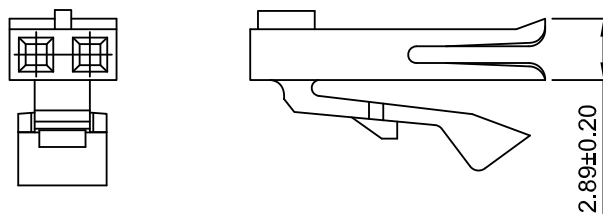
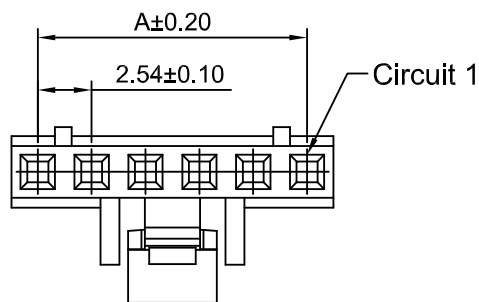

DETAIL FOR 2 POSN ONLY

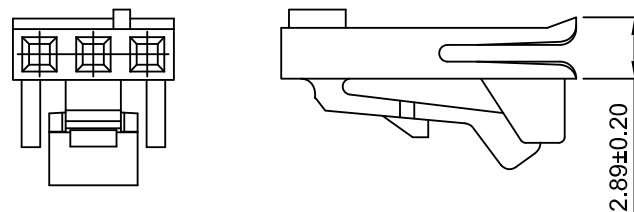
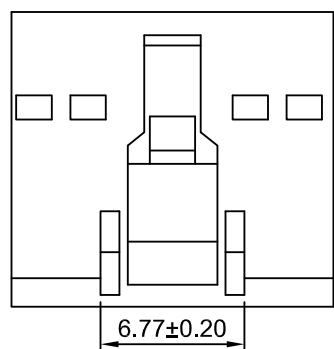

DETAIL FOR 3 POSN ONLY



深圳市华德共创科技有限公司

SHENZHEN HUADE CO-CREATE TECHNOLOGY CO.,LTD

TEL : 0755-27129737 FAX : 0755-29940187

-TOLERANCES- UNLESS OTHERWISE SPECIFIED 公差参数表						TITLE: 2.54mm Pitch Housing 产品名称: 2.54mm Pitch Housing			
X.X	±0.30	X.X°	±3°	APPD: 核准:	XIE	PART NO: 产品编号: HDGC2550H-XP-H1			
X.XX	±0.30	X.XX°	±2°	CHECK: 校对:	WANG	DATE	SCALE	UNIT	CODE NUMBER
X.XXX	±0.10	X.XXX°	±1°	DRAW: 绘图:	WANG	2012-12-10	3:1	mm	A008

修订 REV	标记 MARK	修改摘要 REVISION DESCRIPTION	签名 SIGNATURE	日期 DATE
AO		NEW RELEASE	WANG	2012-12-10

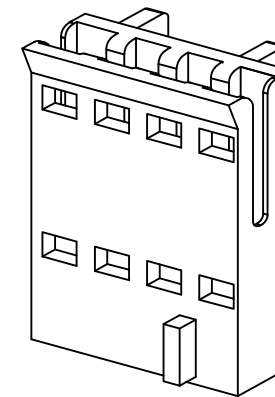
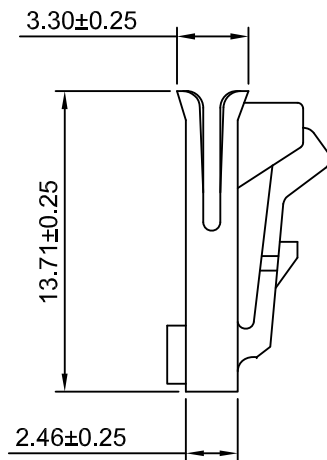
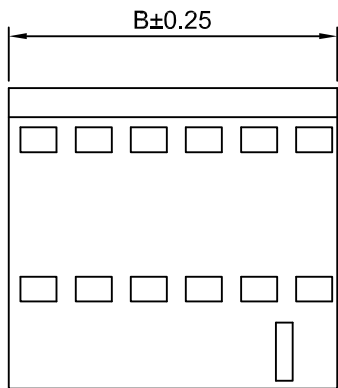

SPECIFICATIONS:

Current Rating: 3A AC,DC
Voltage Rating: 300V AC,DC
Temperature Range: -25°C ~ +85°C
Contact Resistance: 5mΩ Max
Insulation Resistance: 1000MΩ Min
Withstanding Voltage: 1100V AC/minute
Material: PBT30%GF,UL94V-0(Black)

Ordering Information & Dimensions

Circuits	Dimensions(mm)		Circuits	Dimensions(mm)	
	A	B		A	B
2P	2.54	4.92	14P	33.02	35.40
3P	5.08	7.46	15P	35.56	37.94
4P	7.62	10.00	16P	38.10	40.48
5P	10.16	12.54	17P	40.64	43.02
6P	12.70	15.08	18P	43.18	45.56
7P	15.24	17.62	19P	45.72	48.10
8P	17.78	20.16	20P	48.26	50.64
9P	20.32	22.70	21P	50.80	53.18
10P	22.86	25.24	22P	53.34	55.72
11P	25.40	27.78	23P	55.88	58.26
12P	27.94	30.32	24P	58.42	60.80
13P	30.48	32.86	25P	60.96	63.34

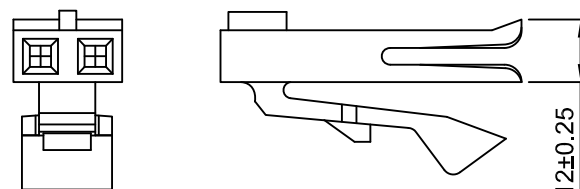
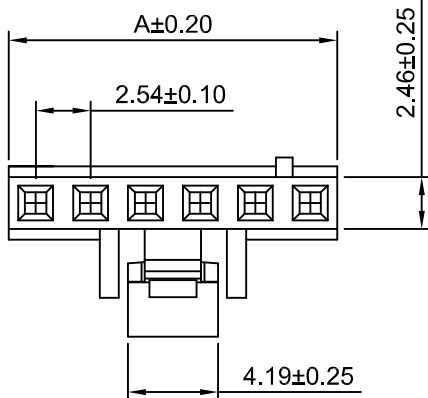

DETAIL FOR 2 POSN ONLY

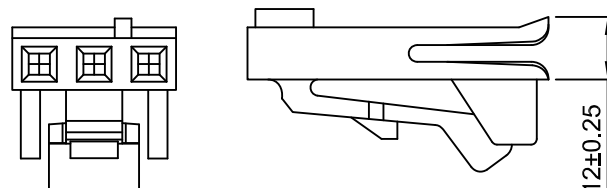
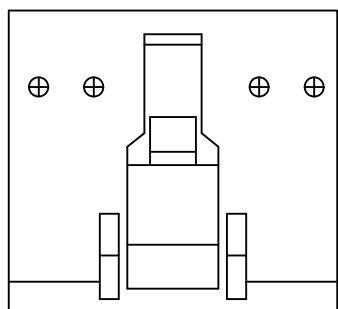

DETAIL FOR 3 POSN ONLY

HDGC 深圳市华德共创科技有限公司
SHENZHEN HUADE CO-CREATE TECHNOLOGY CO.,LTD
TEL : 0755-27129737 FAX : 0755-29940187

-TOLERANCES- UNLESS OTHERWISE SPECIFIED 公差参数表						TITLE: 2.54mm Pitch Housing 产品名称: 2.54mm Pitch Housing			
X.X	±0.30	X.X°	±3°	APPD: 核准:	XIE	PART NO: 产品编号: HDGC2550H-XP-H2			
X.XX	±0.30	X.XX°	±2°	CHECK: 校对:	WANG	DATE	SCALE	UNIT	CODE NUMBER
X.XXX	±0.10	X.XXX°	±1°	DRAW: 绘图:	WANG	2012-12-10	3:1	mm	A008

修订 REV	标记 MARK	修改摘要 REVISION DESCRIPTION	签名 SIGNATURE	日期 DATE
AO		NEW RELEASE	WANG	2012-12-10

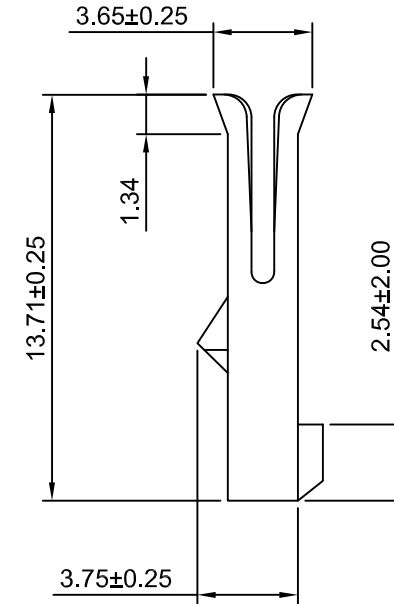
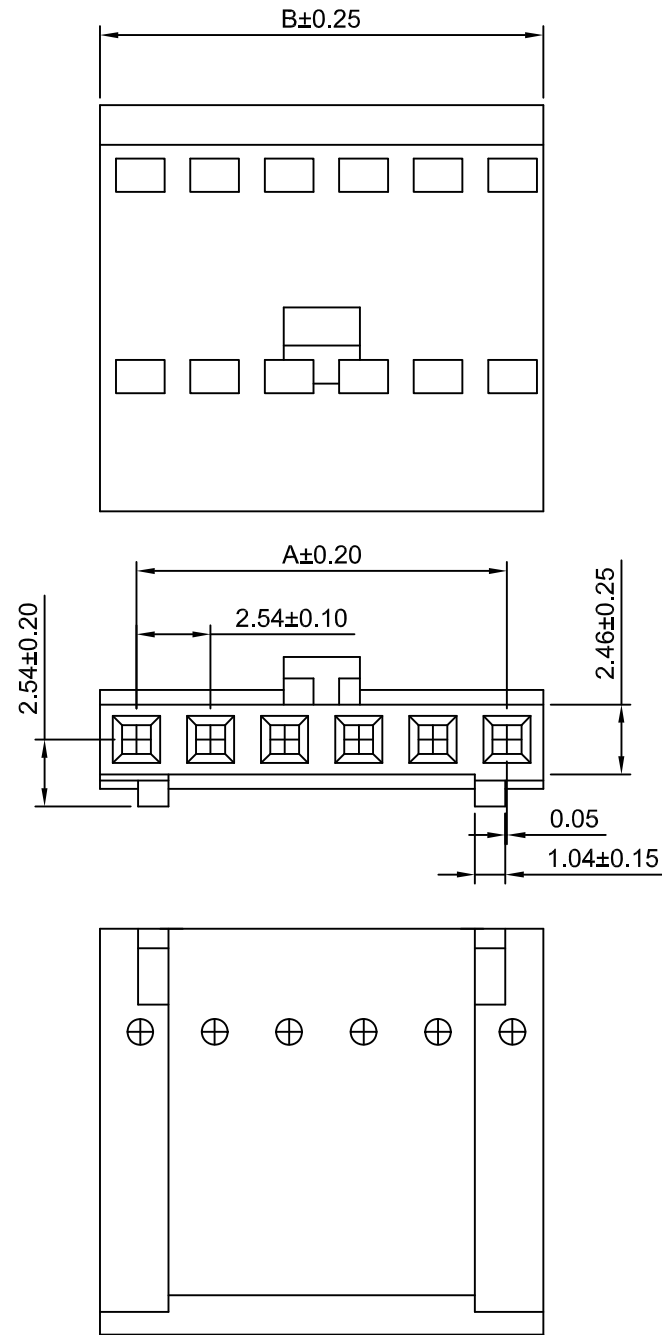

SPECIFICATIONS:

Current Rating: 3A AC,DC
Voltage Rating: 300V AC,DC
Temperature Range: -25°C ~ +85°C
Contact Resistance: 5mΩ Max
Insulation Resistance: 1000MΩ Min
Withstanding Voltage: 1100V AC/minute
Material: PBT30%GF,UL94V-0(Black)

Ordering Information & Dimensions

Circuits	Dimensions(mm)		Circuits	Dimensions(mm)	
	A	B		A	B
2P	2.54	4.92	14P	33.02	35.40
3P	5.08	7.46	15P	35.56	38.94
4P	7.62	10.00	16P	38.10	40.48
5P	10.16	12.54	17P	40.64	43.02
6P	12.70	15.08	18P	43.18	45.56
7P	15.24	17.62	19P	45.72	48.10
8P	17.78	20.16	20P	48.26	50.64
9P	20.32	22.70	21P	50.80	53.18
10P	22.86	25.24	22P	53.34	55.72
11P	25.40	27.78	23P	55.88	58.26
12P	27.94	30.32	24P	58.42	60.80
13P	30.48	32.86	25P	60.96	63.34

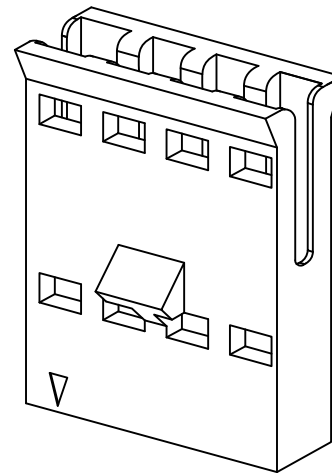

深圳市华德共创科技有限公司

SHENZHEN HUADE CO-CREATE TECHNOLOGY CO.,LTD

TEL : 0755-27129737 FAX : 0755-29940187

-TOLERANCES- UNLESS OTHERWISE SPECIFIED 公差参数表				TITLE: 产品名称: 2.54mm Pitch Housing				
X.X	±0.30	X.X°	±3°	APPD: 核准: XIE	PART NO: 产品编号: HDGC2550H-XP-1			
X.XX	±0.30	X.XX°	±2°	CHECK: 校对: WANG	DATE	SCALE	UNIT	CODE NUMBER
X.XXX	±0.10	X.XXX°	±1°	DRAW: 绘图: WANG	2012-12-10	4:1	mm	A008

修订 REV	标记 MARK	修改摘要 REVISION DESCRIPTION	签名 SIGNATURE	日期 DATE
AO		NEW RELEASE	WANG	2012-12-10

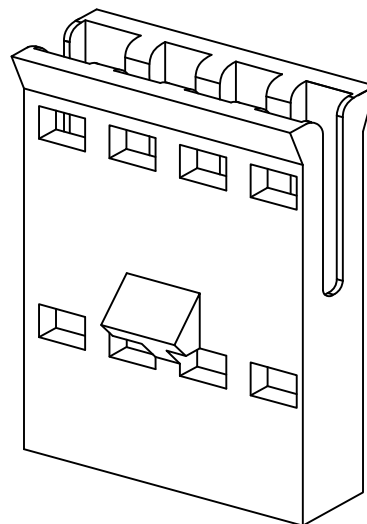
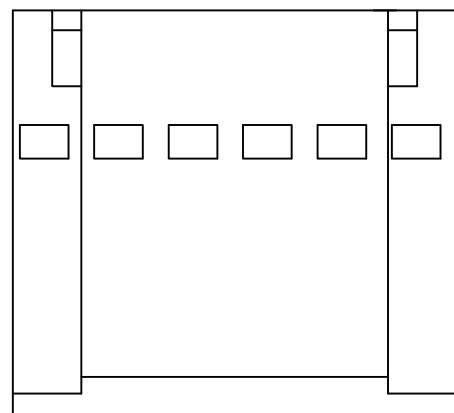
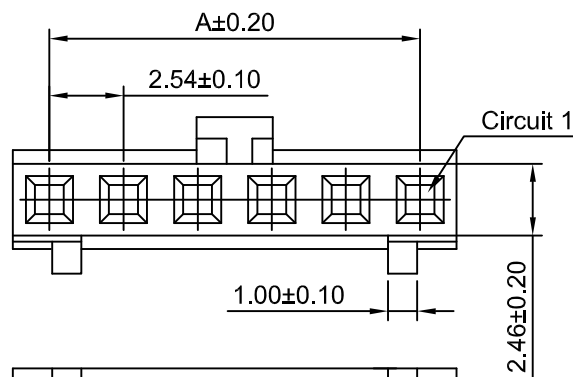
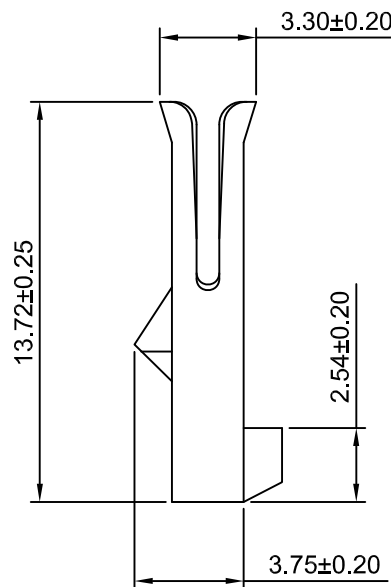
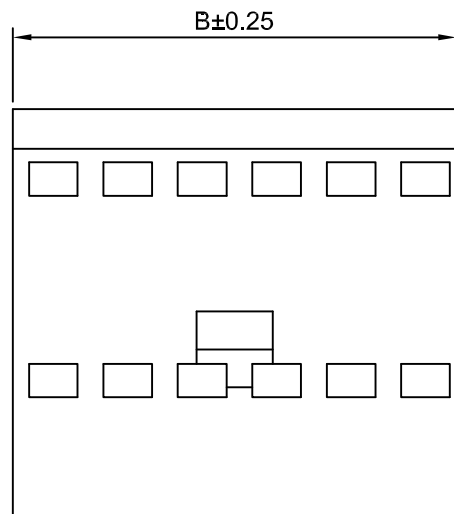

SPECIFICATIONS:

Current Rating: 3A AC,DC
Voltage Rating: 300V AC,DC
Temperature Range: -25°C ~ +85°C
Contact Resistance: 5mΩ Max
Insulation Resistance: 1000MΩ Min
Withstanding Voltage: 1100V AC/minute
Material: PBT30%GF,UL94V-0(Black)

Ordering Information & Dimensions

Circuits	Dimensions(mm)		Circuits	Dimensions(mm)	
	A	B		A	B
2P	2.54	4.92	14P	33.02	35.40
3P	5.08	7.46	15P	35.56	38.94
4P	7.62	10.00	16P	38.10	40.48
5P	10.16	12.54	17P	40.64	43.02
6P	12.70	15.08	18P	43.18	45.56
7P	15.24	17.62	19P	45.72	48.10
8P	17.78	20.16	20P	48.26	50.64
9P	20.32	22.70	21P	50.80	53.18
10P	22.86	25.24	22P	53.34	55.72
11P	25.40	27.78	23P	55.88	58.26
12P	27.94	30.32	24P	58.42	60.80
13P	30.48	32.86	25P	60.96	63.34

HDGC 深圳市华德共创科技有限公司
SHENZHEN HUADE CO-CREATE TECHNOLOGY CO.,LTD
TEL : 0755-27129737 FAX : 0755-29940187

-TOLERANCES- UNLESS OTHERWISE SPECIFIED 公差参数表						TITLE: 2.54mm Pitch 产品名称: Housing			
X.X	±0.30	X.X°	±3°	APPD: 核准:	XIE	PART NO: 产品编号: HDGC2550H-XP-11			
X.XX	±0.30	X.XX°	±2°	CHECK: 校对:	WANG	DATE	SCALE	UNIT	CODE NUMBER
X.XXX	±0.10	X.XXX°	±1°	DRAW: 绘图:	WANG	2012-12-10	4:1	mm	A008

修订 REV	标记 MARK	修改摘要 REVISION DESCRIPTION	签名 SIGNATURE	日期 DATE
AO		NEW RELEASE	WANG	2012-12-10

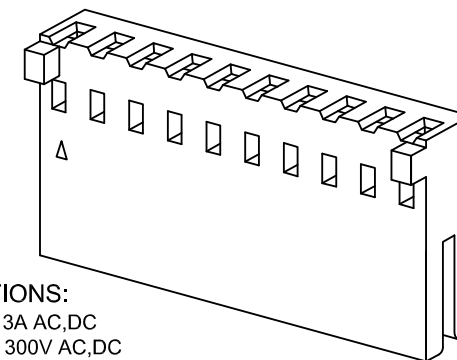
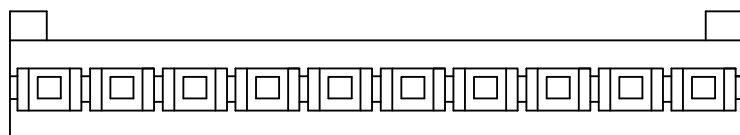
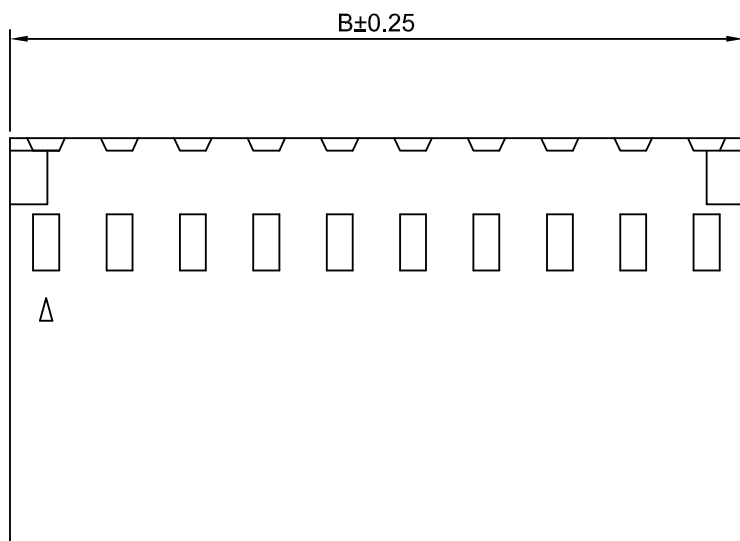
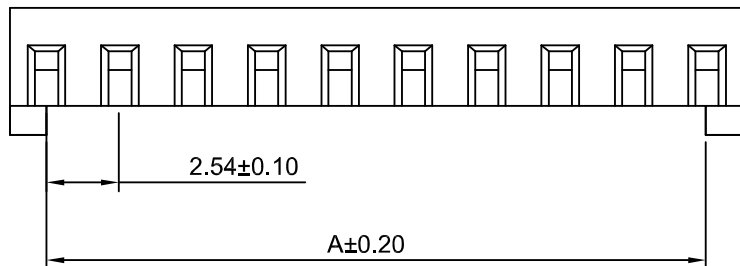

SPECIFICATIONS:

Current Rating: 3A AC,DC
Voltage Rating: 300V AC,DC
Temperature Range: -25°C ~ +85°C
Contact Resistance: 5mΩ Max
Insulation Resistance: 1000MΩ Min
Withstanding Voltage: 1100V AC/minute
Material: PBT30%GF, UL94V-0(Black)

Ordering Information & Dimensions

Circuits	Dimensions(mm)		Circuits	Dimensions(mm)	
	A	B		A	B
2P	2.54	5.08	14P	33.02	35.56
3P	5.08	7.62	15P	35.56	38.10
4P	7.62	10.16	16P	38.10	40.64
5P	10.16	12.70	17P	40.64	43.18
6P	12.70	15.24	18P	43.18	45.72
7P	15.24	17.78	19P	45.72	48.26
8P	17.78	20.32	20P	48.26	50.80
9P	20.32	22.86	21P	50.80	53.34
10P	22.86	25.40	22P	53.34	55.88
11P	25.40	27.94	23P	55.88	58.42
12P	27.94	30.48	24P	58.42	60.96
13P	30.48	33.02	25P	60.96	63.50

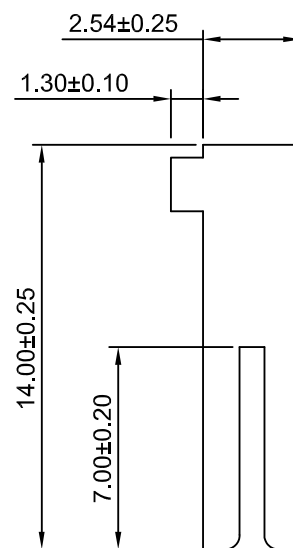

深圳市华德共创科技有限公司

SHENZHEN HUADE CO-CREATE TECHNOLOGY CO.,LTD

TEL : 0755-27129737 FAX : 0755-29940187

-TOLERANCES- UNLESS OTHERWISE SPECIFIED 公差参数表						TITLE: 2.54mm Pitch Housing 产品名称: 2.54mm Pitch Housing			
X.X	±0.30	X.X°	±3°	APPD: 核准:	XIE	PART NO: 产品编号: HDGC2550H-XP-J			
X.XX	±0.30	X.XX°	±2°	CHECK: 校对:	WANG	DATE	SCALE	UNIT	CODE NUMBER
X.XXX	±0.10	X.XXX°	±1°	DRAW: 绘图:	WANG	2012-12-10	4:1	mm	A008

修订 REV	标记 MARK	修改摘要 REVISION DESCRIPTION	签名 SIGNATURE	日期 DATE
AO		NEW RELEASE	WANG	2012-12-10

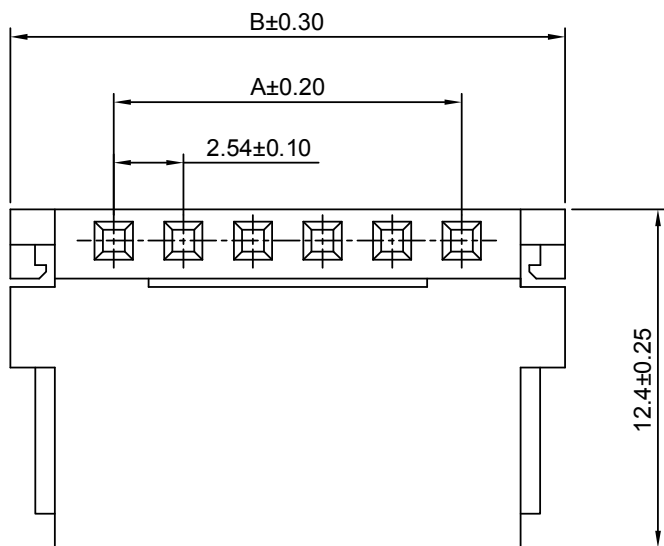

12.4±0.25

Ordering Information:

HDGC2550HD-XP - *
1 2

1.Part No.

2.Finish

(blank) :Tin over Nickel

G :Gold over Nickel

SPECIFICATIONS:

Current Rating: 3A AC,DC

Voltage Rating: 300V AC,DC

Temperature Range: -25°C ~ +85°C

Contact Resistance: 5mΩ Max

Insulation Resistance: 1000MΩ Min

Withstanding Voltage: 1100V AC/minute

Terminal Material:Phosphor Bronze/Tin over Nickel

Material: Nylon 66,UL94V-0(Blue)

Ordering Information & Dimensions

Circuits	Dimensions(mm)		Circuits	Dimensions(mm)	
	A	B		A	B
2P	2.54	10.08	20P	48.26	55.80
3P	5.08	12.62	21P	50.80	58.34
4P	7.62	15.16	22P	53.34	60.88
5P	10.16	17.70	23P	55.88	63.42
6P	12.70	20.24	24P	58.42	65.96
7P	15.24	22.78	25P	60.96	68.50
8P	17.78	25.32	26P	63.50	71.04
9P	20.32	27.86	27P	66.04	73.58
10P	22.86	30.40	28P	68.58	76.12
11P	25.40	32.94	29P	71.12	78.66
12P	27.94	35.48	30P	73.66	81.20
13P	30.48	38.02	31P	76.20	83.74
14P	33.02	40.56	32P	78.74	86.28
15P	35.56	43.10	33P	81.28	88.82
16P	38.10	45.64	34P	83.82	91.36
17P	40.64	48.18	35P	86.36	93.90
18P	43.18	50.72	36P	88.90	96.44
19P	45.72	53.26			

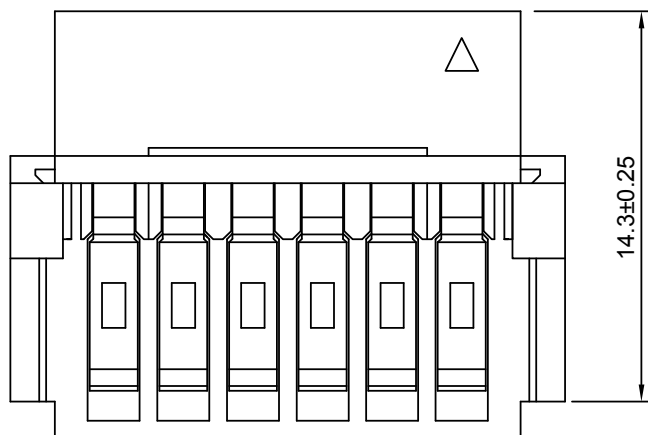

2.54±0.20

15.6±0.25

深圳市华德共创科技有限公司

SHENZHEN HUADE CO-CREATE TECHNOLOGY CO.,LTD

TEL : 0755-27129737 FAX : 0755-29940187

-TOLERANCES- UNLESS OTHERWISE SPECIFIED 公差参数表				TITLE: 2.54mm Pitch Housing 产品名称: 2.54mm Pitch Housing							
X.X	±0.30	X.X°	±3°	APPD: 核准:	XIE			PART NO: 产品编号:	HDGC2550HD-XP		
X.XX	±0.30	X.XX°	±2°	CHECK: 校对:	WANG			DATE	SCALE	UNIT	CODE NUMBER
X.XXX	±0.10	X.XXX°	±1°	DRAW: 绘图:	WANG			2012-12-10	4:1	mm	A008

修订 REV	标记 MARK	修改摘要 REVISION DESCRIPTION	签名 SIGNATURE	日期 DATE
AO		NEW RELEASE	WANG	2017-05-10

SPECIFICATIONS:

Current Rating: 3A AC,DC
Voltage Rating: 300V AC,DC
Temperature Range: -25°C ~ +85°C
Contact Resistance: 5mΩ Max
Insulation Resistance: 1000MΩ Min
Withstanding Voltage: 1100V AC/minute
Terminal Material: Phosphor Bronze/Tin over Nickel
Material: PP, UL94V-0(Blue)

Ordering Information & Dimensions

Circuits	Dimensions(mm)		Circuits	Dimensions(mm)	
	A	B		A	B
2P	2.54	9.91	20P	48.26	55.63
3P	5.08	12.45	21P	50.80	58.17
4P	7.62	14.99	22P	53.34	60.71
5P	10.16	17.53	23P	55.88	63.25
6P	12.70	20.07	24P	58.42	65.79
7P	15.24	22.61	25P	60.96	68.33
8P	17.78	25.15	26P	63.50	70.87
9P	20.32	27.69	27P	66.04	73.41
10P	22.86	30.23	28P	68.58	75.95
11P	25.40	32.77	29P	71.12	78.49
12P	27.94	35.31	30P	73.66	81.03
13P	30.48	37.85	31P	76.20	83.57
14P	33.02	40.39	32P	78.74	86.11
15P	35.56	42.93	33P	81.28	88.65
16P	38.10	45.47	34P	83.82	91.19
17P	40.64	48.01	35P	86.36	93.73
18P	43.18	50.55	36P	88.90	96.27
19P	45.72	53.09			

Ordering Information:

HDGC2550HDM-XP - *
1 2

1.Part No.

2.Finish

(blank) :Tin over Nickel

G :Gold over Nickel

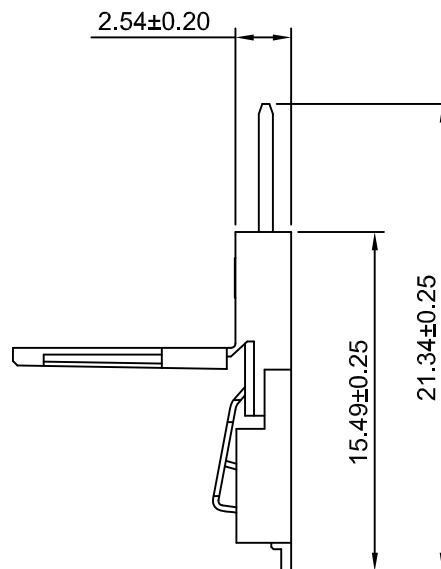
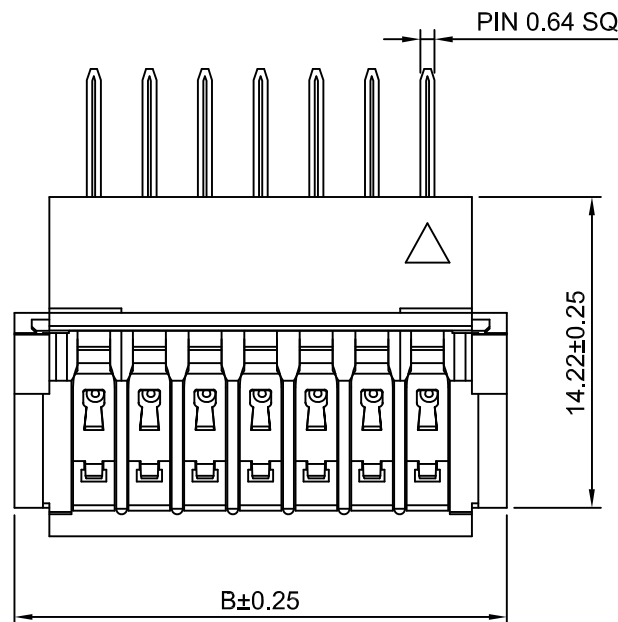
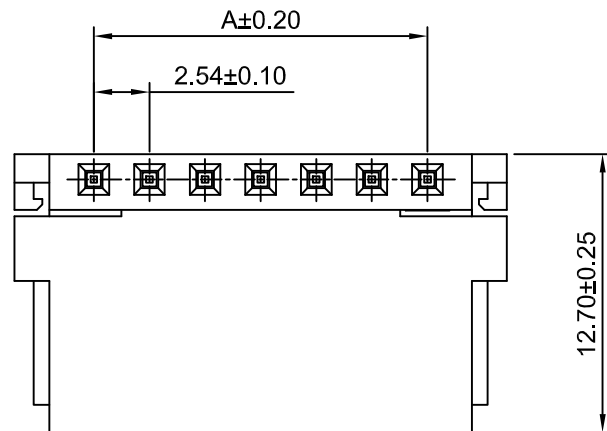

深圳市华德共创科技有限公司

SHENZHEN HUADE CO-CREATE TECHNOLOGY CO.,LTD

TEL : 0755-27129737 FAX : 0755-29940187

-TOLERANCES- UNLESS OTHERWISE SPECIFIED 公差参数表				TITLE: 产品名称: 2.54mm Pitch Housing	
X.X	±0.30	X.X°	±3°	APPD: 核准:	XIE
X.XX	±0.30	X.XX°	±2°	CHECK: 校对:	WANG
X.XXX	±0.10	X.XXX°	±1°	DRAW: 绘图:	WANG
PART NO: 产品编号:				HDGC2550HDM-XP	
DATE		SCALE	UNIT	CODE NUMBER	
2017-05-10		3:1	mm	A008	

修订 REV	标记 MARK	修改摘要 REVISION DESCRIPTION	签名 SIGNATURE	日期 DATE
AO		NEW RELEASE	WANG	2017-05-10

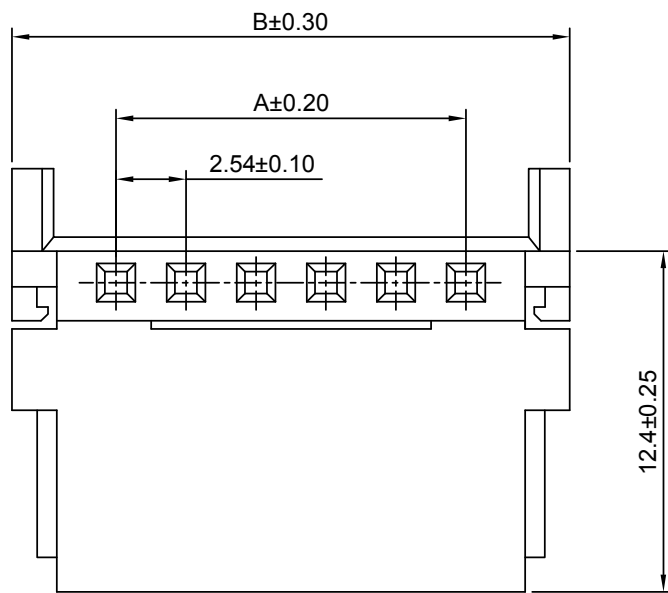

Ordering Information:
HDGC2550HE-XP - *
1 2

- Part No.
- Finish
(blank) :Tin over Nickel
G :Gold over Nickel

SPECIFICATIONS:

Current Rating: 3A AC,DC
Voltage Rating: 300V AC,DC
Temperature Range: -25°C ~ +85°C
Contact Resistance: 5mΩ Max
Insulation Resistance: 1000MΩ Min
Withstanding Voltage: 1100V AC/minute
Terminal Material: Phosphor Bronze/Tin over Nickel
Material: Nylon 66, UL94V-0(Blue)

Ordering Information & Dimensions

Circuits	Dimensions(mm)		Circuits	Dimensions(mm)	
	A	B		A	B
2P	2.54	10.08	19P	45.72	53.26
3P	5.08	12.62	20P	48.26	55.80
4P	7.62	15.16	21P	50.80	58.34
5P	10.16	17.70	22P	53.34	60.88
6P	12.70	20.24	23P	55.88	63.42
7P	15.24	22.78	24P	58.42	65.96
8P	17.78	25.32	25P	60.96	68.50
9P	20.32	27.86	26P	63.50	71.04
10P	22.86	30.40	27P	66.04	73.58
11P	25.40	32.94	28P	68.58	76.12
12P	27.94	35.48	29P	71.12	78.66
13P	30.48	38.02	30P	73.66	81.20
14P	33.02	40.56	31P	76.20	83.74
15P	35.56	43.10	32P	78.74	86.28
16P	38.10	45.64	33P	81.28	88.82
17P	40.64	48.18	34P	83.82	91.36
18P	43.18	50.72			

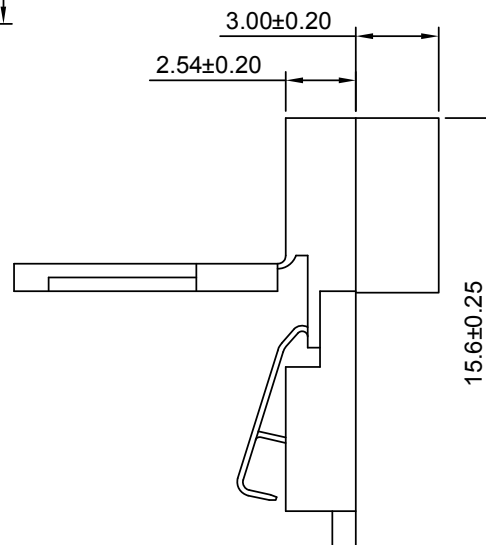
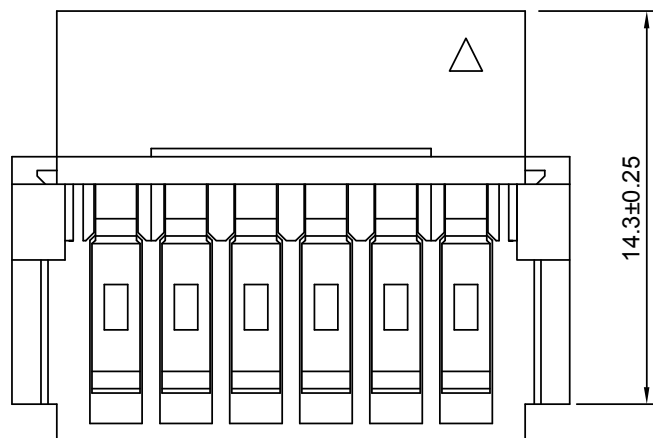

深圳市华德共创科技有限公司

SHENZHEN HUADE CO-CREATE TECHNOLOGY CO.,LTD

TEL : 0755-27129737 FAX : 0755-29940187

-TOLERANCES- UNLESS OTHERWISE SPECIFIED 公差参数表						TITLE: 2.54mm Pitch Housing 产品名称:			
X.X	±0.30	X.X°	±3°	APPD: 核准:	XIE	PART NO: 产品编号: HDGC2550HE-XP			
X.XX	±0.30	X.XX°	±2°	CHECK: 校对:	WANG	DATE	SCALE	UNIT	CODE NUMBER
X.XXX	±0.10	X.XXX°	±1°	DRAW: 绘图:	WANG	2017-05-10	4:1	mm	A008

修订 REV	标记 MARK	修改摘要 REVISION DESCRIPTION	签名 SIGNATURE	日期 DATE
AO		NEW RELEASE	WANG	2017-05-10

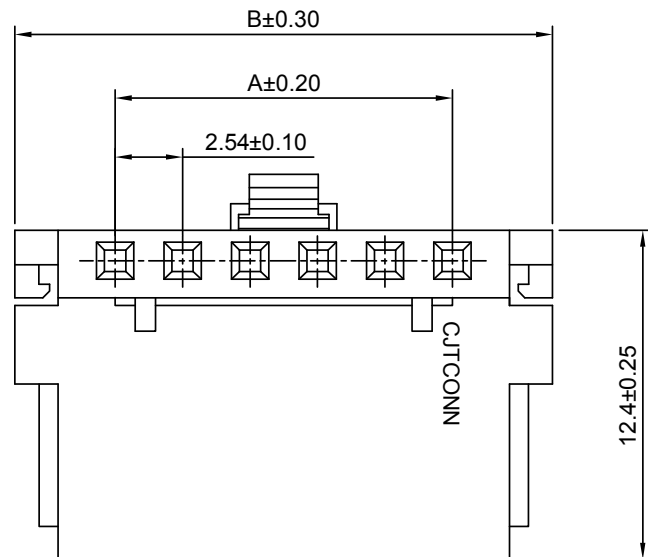

Ordering Information:
HDGC2550HF-XP - *
1 2

- Part No.
- Finish
(blank) :Tin over Nickel
G :Gold over Nickel

SPECIFICATIONS:

Current Rating: 3A AC,DC
Voltage Rating: 300V AC,DC
Temperature Range: -25°C ~ +85°C
Contact Resistance: 5mΩ Max
Insulation Resistance: 1000MΩ Min
Withstanding Voltage: 1100V AC/minute
Terminal Material:Phosphor Bronze/Tin over Nickel
Material: Nylon 66,UL94V-0(Blue)

Ordering Information & Dimensions

Circuits	Dimensions(mm)		Circuits	Dimensions(mm)	
	A	B		A	B
6P	12.70	20.24	21P	50.80	58.34
7P	15.24	22.78	22P	53.34	60.88
8P	17.78	25.32	23P	55.88	63.42
9P	20.32	27.86	24P	58.42	65.96
10P	22.86	30.40	25P	60.96	68.50
11P	25.40	32.94	26P	63.50	71.04
12P	27.94	35.48	27P	66.04	73.58
13P	30.48	38.02	28P	68.58	76.12
14P	33.02	40.56	29P	71.12	78.66
15P	35.56	43.10	30P	73.66	81.20
16P	38.10	45.64	31P	76.20	83.74
17P	40.64	48.18	32P	78.74	86.28
18P	43.18	50.72	33P	81.28	88.82
19P	45.72	53.26	34P	83.82	91.36
20P	48.26	55.80			

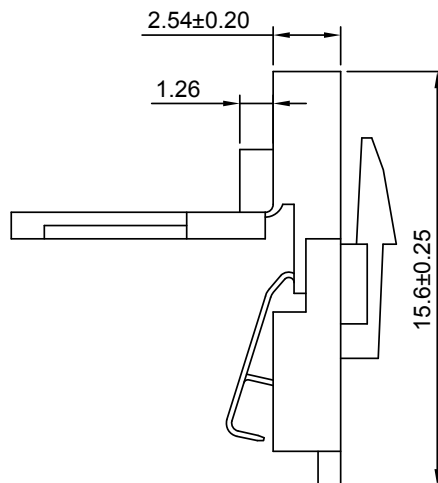
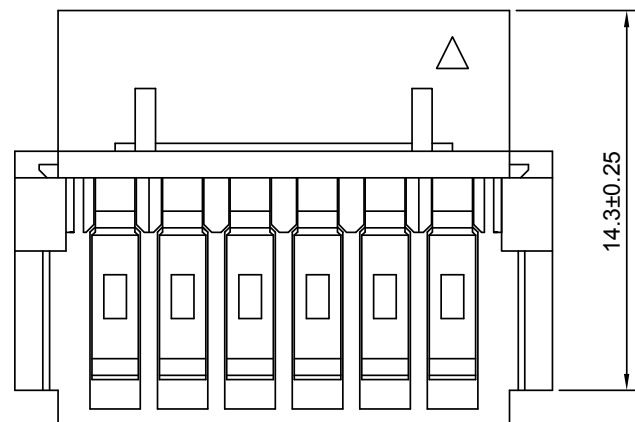

深圳市华德共创科技有限公司

SHENZHEN HUADE CO-CREATE TECHNOLOGY CO.,LTD

TEL : 0755-27129737 FAX : 0755-29940187

-TOLERANCES- UNLESS OTHERWISE SPECIFIED 公差参数表				TITLE: 产品名称: 2.54mm Pitch Housing	
X.X	±0.30	X.X°	±3°	APPD: 核准:	XIE
X.XX	±0.30	X.XX°	±2°	CHECK: 校对:	WANG
X.XXX	±0.10	X.XXX°	±1°	DRAW: 绘图:	WANG
PART NO: 产品编号:		HDGC2550HF-XP			
DATE	SCALE	UNIT	CODE NUMBER		
2017-05-10	4:1	mm	A008		

修订 REV	标记 MARK	修改摘要 REVISION DESCRIPTION	签名 SIGNATURE	日期 DATE
AO		NEW RELEASE	WANG	2017-05-10

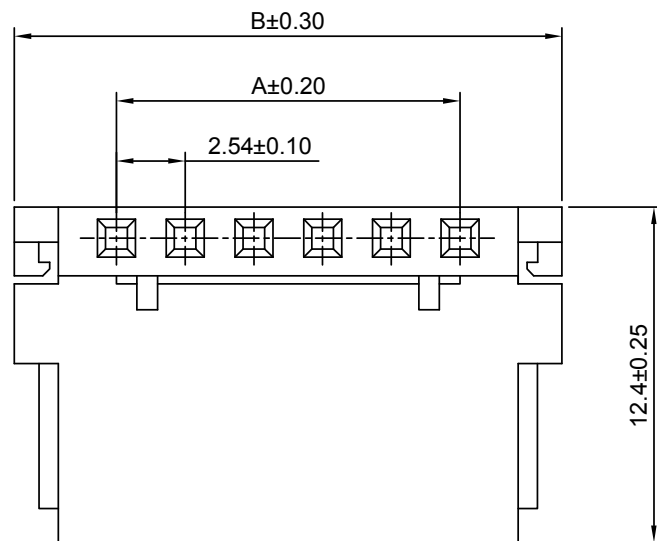

Ordering Information:

HDGC2550HG-XP - *
1 2

1.Part No.

2.Finish

(blank) :Tin over Nickel

G :Gold over Nickel

SPECIFICATIONS:

Current Rating: 3A AC,DC

Voltage Rating: 300V AC,DC

Temperature Range: -25°C ~ +85°C

Contact Resistance: 5mΩ Max

Insulation Resistance: 1000MΩ Min

Withstanding Voltage: 1100V AC/minute

Terminal Material:Phosphor Bronze/Tin over Nickel

Material: Nylon 66,UL94V-0(Blue)

Ordering Information & Dimensions

Circuits	Dimensions(mm)		Circuits	Dimensions(mm)	
	A	B		A	B
6P	12.70	20.24	21P	50.80	58.34
7P	15.24	22.78	22P	53.34	60.88
8P	17.78	25.32	23P	55.88	63.42
9P	20.32	27.86	24P	58.42	65.96
10P	22.86	30.40	25P	60.96	68.50
11P	25.40	32.94	26P	63.50	71.04
12P	27.94	35.48	27P	66.04	73.58
13P	30.48	38.02	28P	68.58	76.12
14P	33.02	40.56	29P	71.12	78.66
15P	35.56	43.10	30P	73.66	81.20
16P	38.10	45.64	31P	76.20	83.74
17P	40.64	48.18	32P	78.74	86.28
18P	43.18	50.72	33P	81.28	88.82
19P	45.72	53.26	34P	83.82	91.36
20P	48.26	55.80			

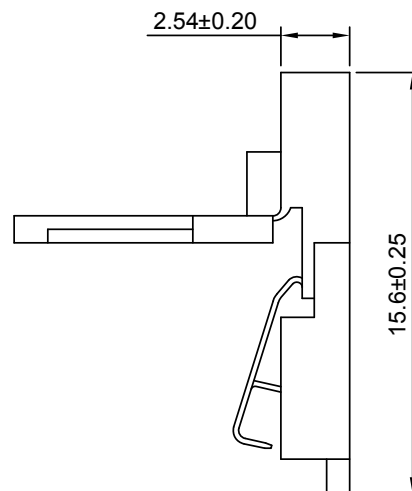
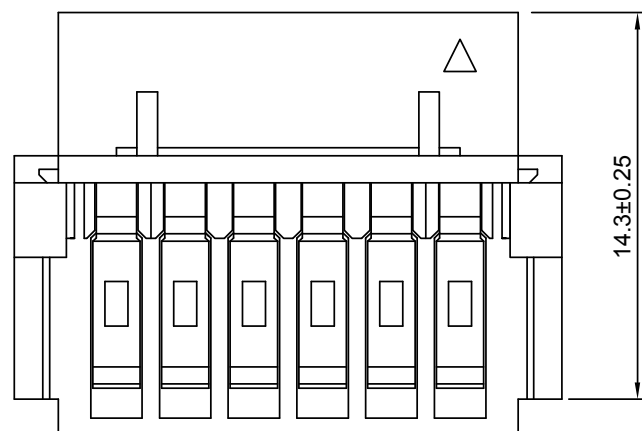

深圳市华德共创科技有限公司

SHENZHEN HUADE CO-CREATE TECHNOLOGY CO.,LTD

TEL : 0755-27129737 FAX : 0755-29940187

-TOLERANCES- UNLESS OTHERWISE SPECIFIED 公差参数表				TITLE: 产品名称 : 2.54mm Pitch Housing				
X.X	±0.30	X.X°	±3°	APPD: 核准 : XIE	PART NO: 产品编号 : HDGC2550HG-XP			
X.XX	±0.30	X.XX°	±2°	CHECK: 校对 : WANG	DATE	SCALE	UNIT	CODE NUMBER
X.XXX	±0.10	X.XXX°	±1°	DRAW: 绘图 : WANG	2017-05-10	4:1	mm	A008

修订 REV	标记 MARK	修改摘要 REVISION DESCRIPTION	签名 SIGNATURE	日期 DATE
AO		NEW RELEASE	WANG	2017-05-10

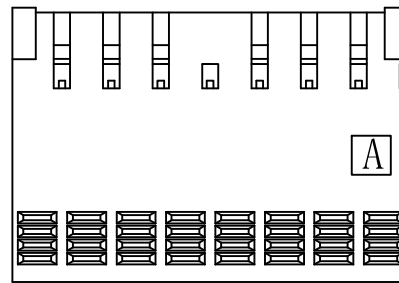
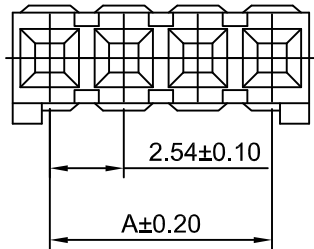

8P~36P

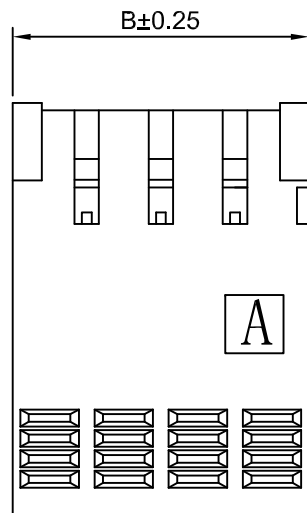
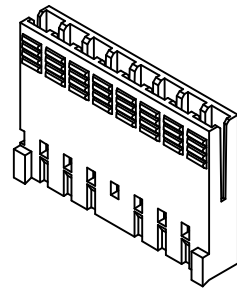

2P~7P

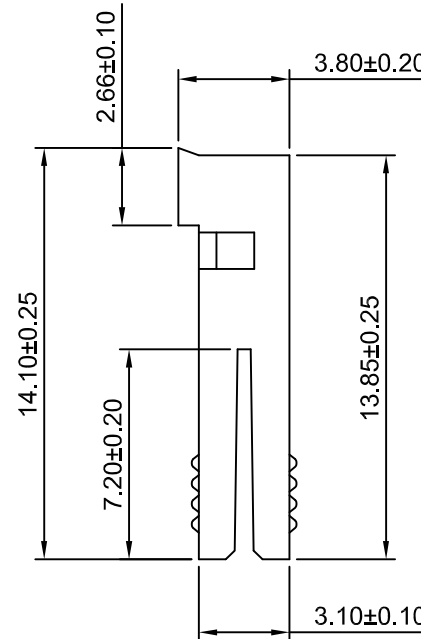

SPECIFICATIONS:

Current Rating: 3A AC,DC
Voltage Rating: 300V AC,DC
Temperature Range: -25°C ~ +85°C
Contact Resistance: 5mΩ Max
Insulation Resistance: 1000MΩ Min
Withstanding Voltage: 1100V AC/minute
Material: PBT30%GF,UL94V-0(Blue)

Ordering Information & Dimensions

Circuits	Dimensions(mm)		Circuits	Dimensions(mm)	
	A	B		A	B
2P	2.54	5.08	20P	48.26	50.80
3P	5.08	7.62	21P	50.80	53.34
4P	7.62	10.16	22P	53.34	55.88
5P	10.16	12.70	23P	55.88	58.42
6P	12.70	15.24	24P	58.42	60.96
7P	15.24	17.78	25P	60.96	63.50
8P	17.78	20.32	26P	63.50	66.04
9P	20.32	22.86	27P	66.04	68.58
10P	22.86	25.40	28P	68.58	71.12
11P	25.40	27.94	29P	71.12	73.66
12P	27.94	30.48	30P	73.66	76.20
13P	30.48	33.02	31P	76.20	78.74
14P	33.02	35.56	32P	78.74	81.28
15P	35.56	38.10	33P	81.28	83.82
16P	38.10	40.64	34P	83.82	86.36
17P	40.64	43.18	35P	86.36	88.90
18P	43.18	45.72	36P	88.90	91.44
19P	45.72	48.26			



深圳市华德共创科技有限公司

SHENZHEN HUADE CO-CREATE TECHNOLOGY CO.,LTD

TEL : 0755-27129737 FAX : 0755-29940187

-TOLERANCES- UNLESS OTHERWISE SPECIFIED 公差参数表						TITLE: 2.54mm Pitch Housing 产品名称:			
X.X	±0.30	X.X°	±3°	APPD: 核准:	XIE	PART NO: 产品编号: HDGC2550HK-XP			
X.XX	±0.30	X.XX°	±2°	CHECK: 校对:	WANG	DATE	SCALE	UNIT	CODE NUMBER
X.XXX	±0.10	X.XXX°	±1°	DRAW: 绘图:	WANG	2017-05-10	4:1	mm	A008

修订 REV	标记 MARK	修改摘要 REVISION DESCRIPTION	签名 SIGNATURE	日期 DATE
AO		NEW RELEASE	WANG	2017-05-10

SPECIFICATIONS:

Current Rating: 3A AC,DC
Voltage Rating: 300V AC,DC
Temperature Range: -25°C ~ +85°C
Contact Resistance: 5mΩ Max
Insulation Resistance: 1000MΩ Min
Withstanding Voltage: 1100V AC/minute
Material: PBT30%GF,UL94V-0(Blue)

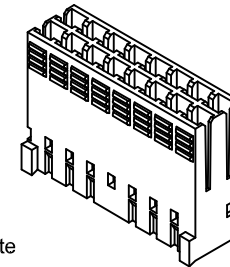

Ordering Information & Dimensions

Circuits	Dimensions(mm)		Circuits	Dimensions(mm)	
	A	B		A	B
2x2P	2.54	5.08	2x20P	48.26	50.80
2x3P	5.08	7.62	2x21P	50.80	53.34
2x4P	7.62	10.16	2x22P	53.34	55.88
2x5P	10.16	12.70	2x23P	55.88	58.42
2x6P	12.70	15.24	2x24P	58.42	60.96
2x7P	15.24	17.78	2x25P	60.96	63.50
2x8P	17.78	20.32	2x26P	63.50	66.04
2x9P	20.32	22.86	2x27P	66.04	68.58
2x10P	22.86	25.40	2x28P	68.58	71.12
2x11P	25.40	27.94	2x29P	71.12	73.66
2x12P	27.94	30.48	2x30P	73.66	76.20
2x13P	30.48	33.02	2x31P	76.20	78.74
2x14P	33.02	35.56	2x32P	78.74	81.28
2x15P	35.56	38.10	2x33P	81.28	83.82
2x16P	38.10	40.64	2x34P	83.82	86.36
2x17P	40.64	43.18	2x35P	86.36	88.90
2x18P	43.18	45.72	2x36P	88.90	91.44
2x19P	45.72	48.26			

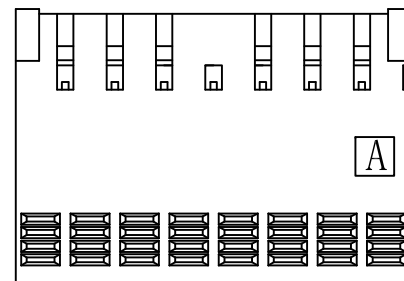
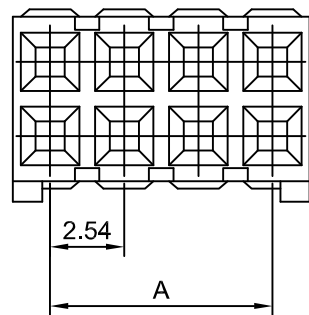

2x8P~2x36P

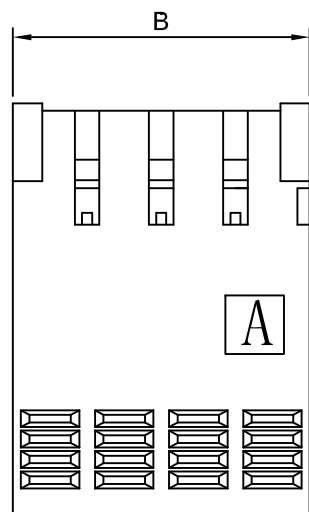

2x2P~2x7P

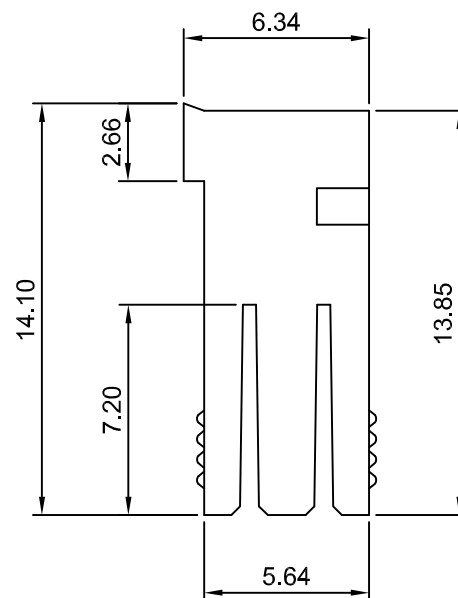

深圳市华德共创科技有限公司

SHENZHEN HUADE CO-CREATE TECHNOLOGY CO.,LTD

TEL : 0755-27129737 FAX : 0755-29940187

-TOLERANCES- UNLESS OTHERWISE SPECIFIED 公差参数表						TITLE: 2.54mm Pitch Housing 产品名称:			
X.X	±0.30	X.X°	±3°	APPD: 核准:	XIE	PART NO: 产品编号: HDGC2550HK-2xXP			
X.XX	±0.30	X.XX°	±2°	CHECK: 校对:	WANG	DATE	SCALE	UNIT	CODE NUMBER
X.XXX	±0.10	X.XXX°	±1°	DRAW: 绘图:	WANG	2017-05-10	4:1	mm	A008

修订 REV	标记 MARK	修改摘要 REVISION DESCRIPTION	签名 SIGNATURE	日期 DATE
AO		NEW RELEASE	WANG	2017-05-10

SPECIFICATIONS:

Current Rating: 3A AC,DC
Voltage Rating: 300V AC,DC
Temperature Range: -25°C ~ +85°C
Contact Resistance: 5mΩ Max
Insulation Resistance: 1000MΩ Min
Withstanding Voltage: 1100V AC/minute
Material: PBT30%GF,UL94V-0(Black)

Ordering Information & Dimensions

Circuits	Dimensions(mm)		Circuits	Dimensions(mm)	
	A	B		A	B
2P	2.54	5.08	20P	48.26	50.80
3P	5.08	7.62	21P	50.80	53.34
4P	7.62	10.16	22P	53.34	55.88
5P	10.16	12.70	23P	55.88	58.42
6P	12.70	15.24	24P	58.42	60.96
7P	15.24	17.78	25P	60.96	63.50
8P	17.78	20.32	26P	63.50	66.04
9P	20.32	22.86	27P	66.04	68.58
10P	22.86	25.40	28P	68.58	71.12
11P	25.40	27.94	29P	71.12	73.66
12P	27.94	30.48	30P	73.66	76.20
13P	30.48	33.02	31P	76.20	78.74
14P	33.02	35.56	32P	78.74	81.28
15P	35.56	38.10	33P	81.28	83.82
16P	38.10	40.64	34P	83.82	86.36
17P	40.64	43.18	35P	86.36	88.90
18P	43.18	45.72	36P	88.90	91.44
19P	45.72	48.26			

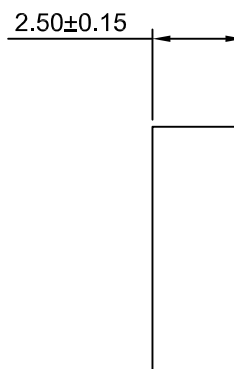
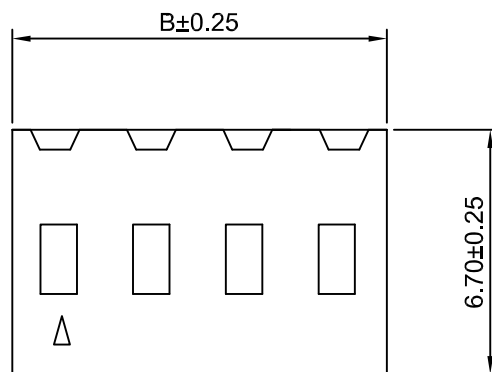
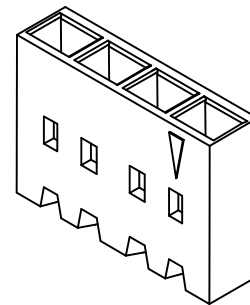
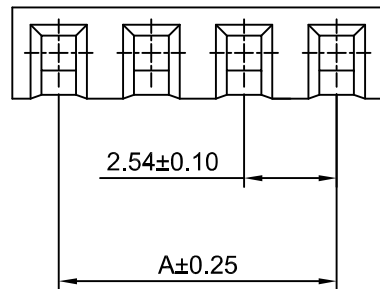

深圳市华德共创科技有限公司

SHENZHEN HUADE CO-CREATE TECHNOLOGY CO.,LTD

TEL : 0755-27129737 FAX : 0755-29940187

-TOLERANCES- UNLESS OTHERWISE SPECIFIED 公差参数表						TITLE: 2.54mm Pitch Housing 产品名称: 2.54mm Pitch Housing			
X.X	±0.30	X.X°	±3°	APPD: 核准:	XIE	PART NO: 产品编号: HDGC2550HL-XP			
X.XX	±0.30	X.XX°	±2°	CHECK: 校对:	WANG	DATE	SCALE	UNIT	CODE NUMBER
X.XXX	±0.10	X.XXX°	±1°	DRAW: 绘图:	WANG	2017-05-10	5:1	mm	A008

修订 REV	标记 MARK	修改摘要 REVISION DESCRIPTION	签名 SIGNATURE	日期 DATE
AO		NEW RELEASE	WANG	2017-05-10

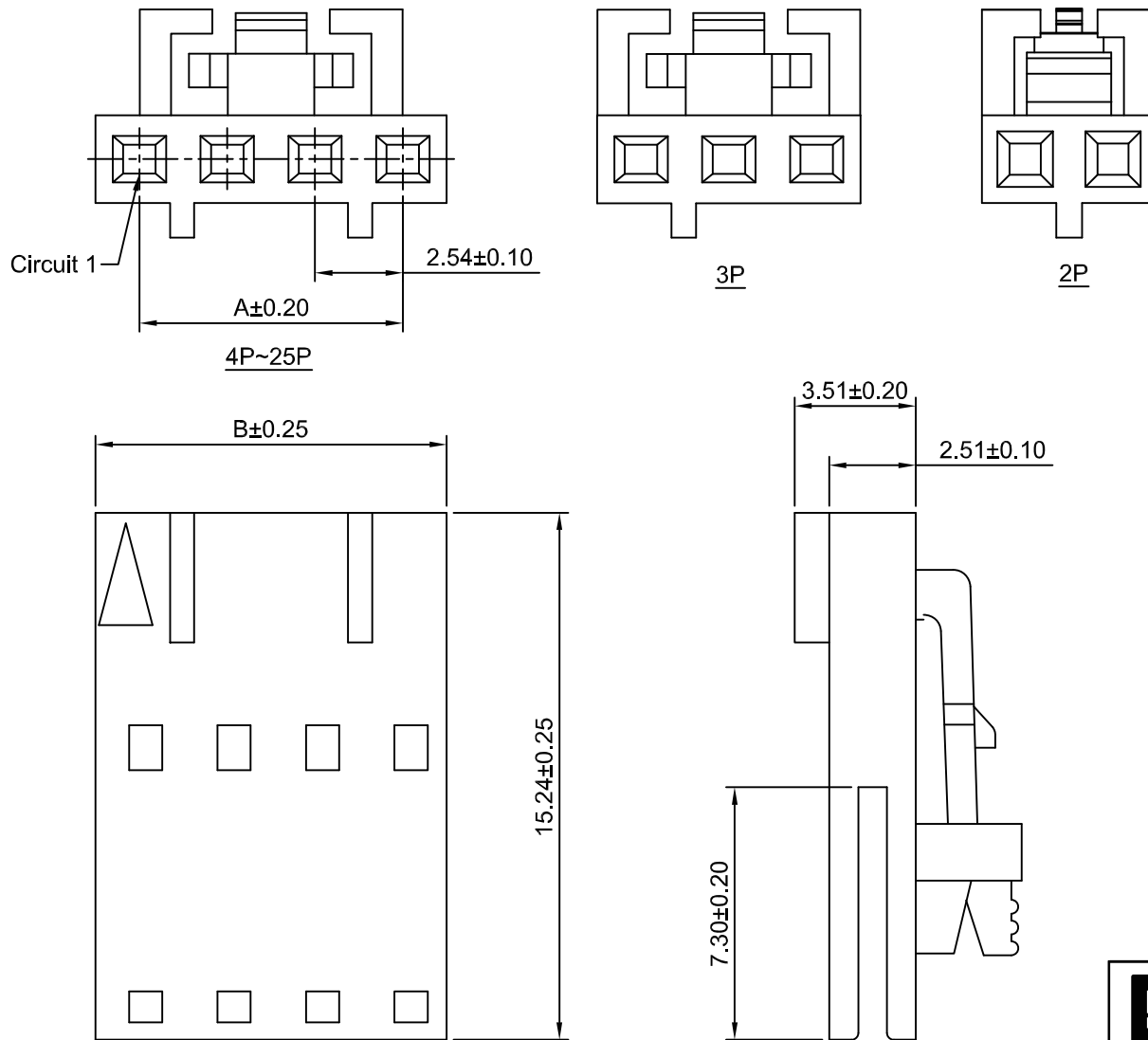

SPECIFICATIONS:

Current Rating: 3A AC,DC
Voltage Rating: 300V AC,DC
Temperature Range: -25°C ~ +85°C
Contact Resistance: 5mΩ Max
Insulation Resistance: 1000MΩ Min
Withstanding Voltage: 1100V AC/minute
Material: PBT30%GF,UL94V-0(Black)

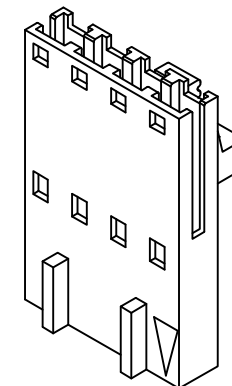

Ordering Information & Dimensions

Circuits	Dimensions(mm)		Circuits	Dimensions(mm)	
	A	B		A	B
2P	2.54	5.08	14P	33.02	35.56
3P	5.08	7.62	15P	35.56	38.10
4P	7.62	10.16	16P	38.10	40.64
5P	10.16	12.70	17P	40.64	43.18
6P	12.70	15.24	18P	43.18	45.72
7P	15.24	17.78	19P	45.72	48.26
8P	17.78	20.32	20P	48.26	50.80
9P	20.32	22.86	21P	50.80	53.34
10P	22.86	25.40	22P	53.34	55.88
11P	25.40	27.94	23P	55.88	58.42
12P	27.94	30.48	24P	58.42	60.96
13P	30.48	33.02	25P	60.96	63.50



深圳市华德共创科技有限公司

SHENZHEN HUADE CO-CREATE TECHNOLOGY CO.,LTD

TEL : 0755-27129737 FAX : 0755-29940187

-TOLERANCES- UNLESS OTHERWISE SPECIFIED 公差参数表						TITLE: 2.54mm Pitch Housing 产品名称:			
X.X	±0.30	X.X°	±3°	APPD: 核准:	XIE	PART NO: 产品编号: HDGC2550H-XP-M			
X.XX	±0.30	X.XX°	±2°	CHECK: 校对:	WANG	DATE	SCALE	UNIT	CODE NUMBER
X.XXX	±0.10	X.XXX°	±1°	DRAW: 绘图:	WANG	2017-05-10	5:1	mm	A008

修订 REV	标记 MARK	修改摘要 REVISION DESCRIPTION	签名 SIGNATURE	日期 DATE
AO		NEW RELEASE	WANG	2017-05-10

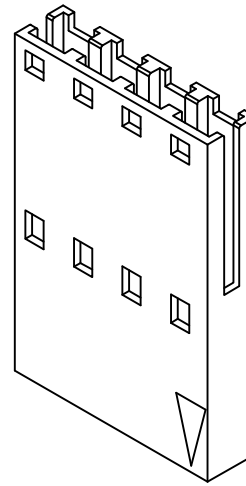
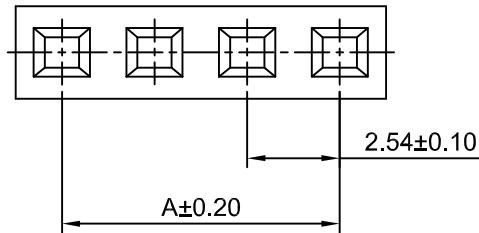

SPECIFICATIONS:

Current Rating: 3A AC,DC
Voltage Rating: 300V AC,DC
Temperature Range: -25°C ~ +85°C
Contact Resistance: 5mΩ Max
Insulation Resistance: 1000MΩ Min
Withstanding Voltage: 1100V AC/minute
Material: PBT30%GF,UL94V-0(Black)

Ordering Information & Dimensions

Circuits	Dimensions(mm)		Circuits	Dimensions(mm)	
	A	B		A	B
2P	2.54	5.08	14P	33.02	35.56
3P	5.08	7.62	15P	35.56	38.10
4P	7.62	10.16	16P	38.10	40.64
5P	10.16	12.70	17P	40.64	43.18
6P	12.70	15.24	18P	43.18	45.72
7P	15.24	17.78	19P	45.72	48.26
8P	17.78	20.32	20P	48.26	50.80
9P	20.32	22.86	21P	50.80	53.34
10P	22.86	25.40	22P	53.34	55.88
11P	25.40	27.94	23P	55.88	58.42
12P	27.94	30.48	24P	58.42	60.96
13P	30.48	33.02	25P	60.96	63.50

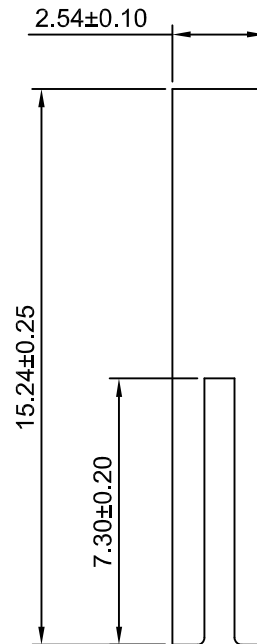
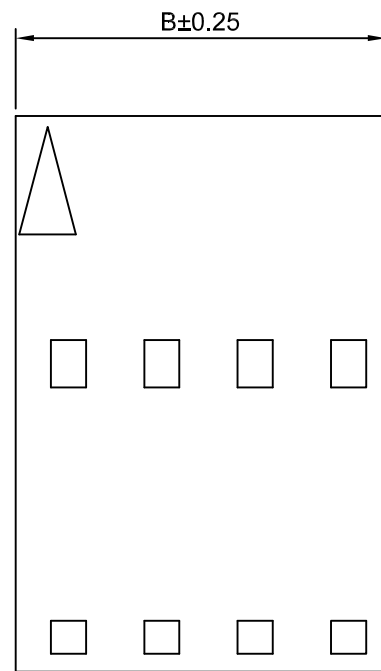

深圳市华德共创科技有限公司
SHENZHEN HUADE CO-CREATE TECHNOLOGY CO.,LTD
TEL : 0755-27129737 FAX : 0755-29940187

-TOLERANCES- UNLESS OTHERWISE SPECIFIED 公差参数表				TITLE: 2.54mm Pitch Housing 产品名称:				
X.X	±0.30	X.X°	±3°	APPD: 核准:	XIE			
X.XX	±0.30	X.XX°	±2°	CHECK: 校对:	DATE	SCALE	UNIT	CODE NUMBER
X.XXX	±0.10	X.XXX°	±1°	DRAW: 绘图:	2017-05-10	5:1	mm	A008

修订 REV	标记 MARK	修改摘要 REVISION DESCRIPTION	签名 SIGNATURE	日期 DATE
AO		NEW RELEASE	WANG	2017-05-10

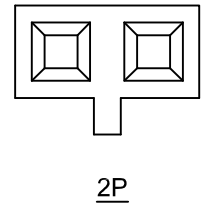
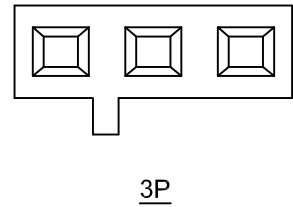
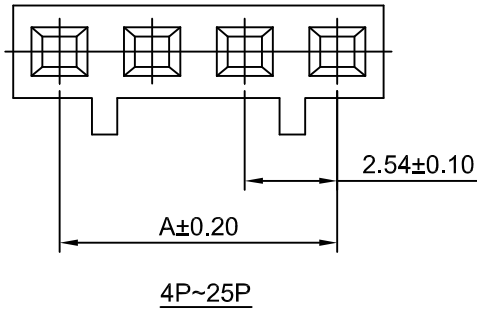
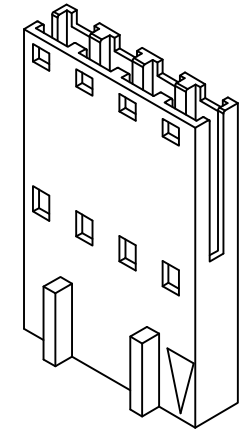

SPECIFICATIONS:

Current Rating: 3A AC,DC
Voltage Rating: 300V AC,DC
Temperature Range: -25°C ~ +85°C
Contact Resistance: 5mΩ Max
Insulation Resistance: 1000MΩ Min
Withstanding Voltage: 1100V AC/minute
Material: PBT30%GF,UL94V-0(Black)

Ordering Information & Dimensions

Circuits	Dimensions(mm)		Circuits	Dimensions(mm)	
	A	B		A	B
2P	2.54	5.08	14P	33.02	35.56
3P	5.08	7.62	15P	35.56	38.10
4P	7.62	10.16	16P	38.10	40.64
5P	10.16	12.70	17P	40.64	43.18
6P	12.70	15.24	18P	43.18	45.72
7P	15.24	17.78	19P	45.72	48.26
8P	17.78	20.32	20P	48.26	50.80
9P	20.32	22.86	21P	50.80	53.34
10P	22.86	25.40	22P	53.34	55.88
11P	25.40	27.94	23P	55.88	58.42
12P	27.94	30.48	24P	58.42	60.96
13P	30.48	33.02	25P	60.96	63.50

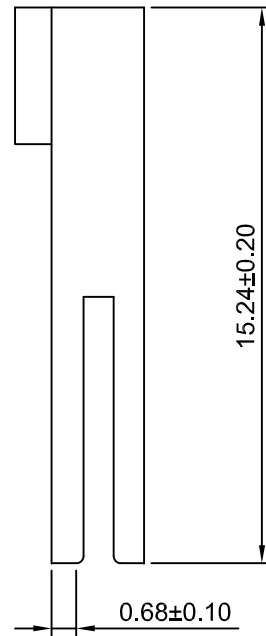
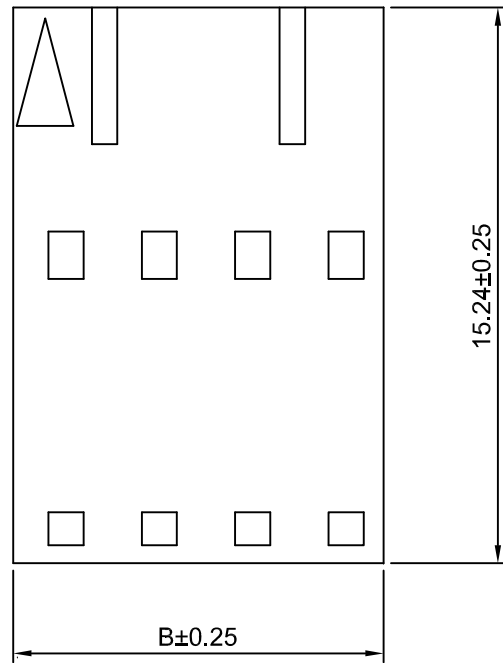

深圳市华德共创科技有限公司

SHENZHEN HUADE CO-CREATE TECHNOLOGY CO.,LTD

TEL : 0755-27129737 FAX : 0755-29940187

-TOLERANCES- UNLESS OTHERWISE SPECIFIED 公差参数表					TITLE: 2.54mm Pitch Housing 产品名称: 2.54mm Pitch Housing					
X.X	±0.30	X.X°	±3°	APPD: 核准:	XIE		PART NO: 产品编号: HDGC2550H-XP-M2			
X.XX	±0.30	X.XX°	±2°	CHECK: 校对:	WANG		DATE	SCALE	UNIT	CODE NUMBER
X.XXX	±0.10	X.XXX°	±1°	DRAW: 绘图:	WANG		2017-05-10	5:1	mm	A008

修订 REV	标记 MARK	修改摘要 REVISION DESCRIPTION	签名 SIGNATURE	日期 DATE
AO		NEW RELEASE	WANG	2017-05-10

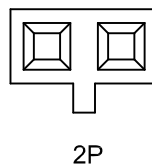
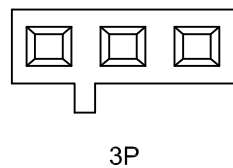
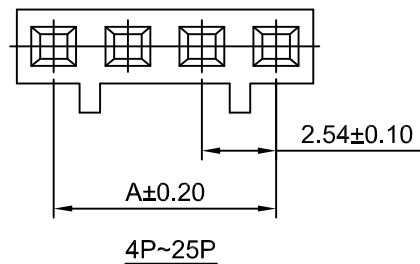

SPECIFICATIONS:

Current Rating: 3A AC,DC
Voltage Rating: 300V AC,DC
Temperature Range: -25°C ~ +85°C
Contact Resistance: 5mΩ Max
Insulation Resistance: 1000MΩ Min
Withstanding Voltage: 1100V AC/minute
Material: PBT30%GF,UL94V-0(Black)

Ordering Information & Dimensions

Circuits	Dimensions(mm)		Circuits	Dimensions(mm)	
	A	B		A	B
2P	2.54	5.08	14P	33.02	35.56
3P	5.08	7.62	15P	35.56	38.10
4P	7.62	10.16	16P	38.10	40.64
5P	10.16	12.70	17P	40.64	43.18
6P	12.70	15.24	18P	43.18	45.72
7P	15.24	17.78	19P	45.72	48.26
8P	17.78	20.32	20P	48.26	50.80
9P	20.32	22.86	21P	50.80	53.34
10P	22.86	25.40	22P	53.34	55.88
11P	25.40	27.94	23P	55.88	58.42
12P	27.94	30.48	24P	58.42	60.96
13P	30.48	33.02	25P	60.96	63.50

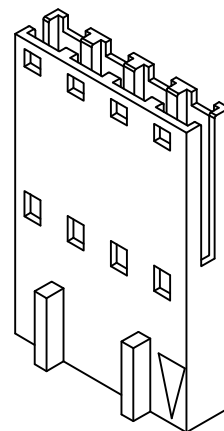
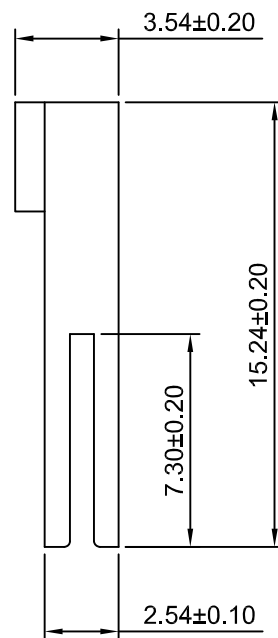
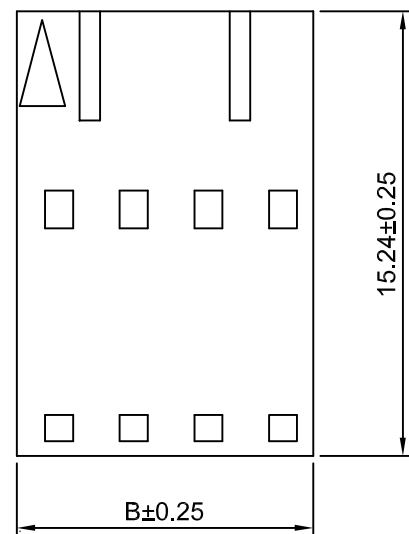

深圳市华德共创科技有限公司

SHENZHEN HUADE CO-CREATE TECHNOLOGY CO.,LTD

TEL : 0755-27129737 FAX : 0755-29940187

-TOLERANCES- UNLESS OTHERWISE SPECIFIED 公差参数表						TITLE: 2.54mm Pitch Housing 产品名称:			
X.X	±0.30	X.X°	±3°	APPD: 核准:	XIE	PART NO: HDGC2550H-XP-M3 产品编号:			
X.XX	±0.30	X.XX°	±2°	CHECK: 校对:	WANG	DATE	SCALE	UNIT	CODE NUMBER
X.XXX	±0.10	X.XXX°	±1°	DRAW: 绘图:	WANG	2017-05-10	4:1	mm	A008

修订 REV	标记 MARK	修改摘要 REVISION DESCRIPTION	签名 SIGNATURE	日期 DATE
AO		NEW RELEASE	WANG	2012-12-10

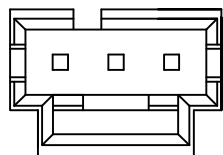
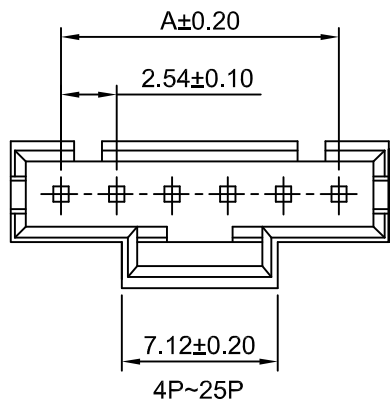

3P

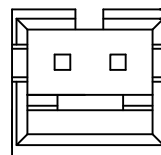

2P

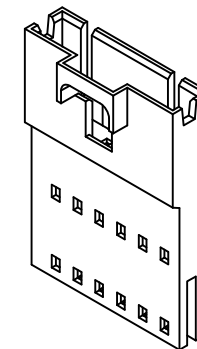

SPECIFICATIONS:

Current Rating: 3A AC,DC
Voltage Rating: 300V AC,DC
Temperature Range: -25°C ~ +85°C
Contact Resistance: 5mΩ Max
Insulation Resistance: 1000MΩ Min
Withstanding Voltage: 1100V AC/minute
Material: PBT30%GF,UL94V-0(Black)

Ordering Information & Dimensions

Circuits	Dimensions(mm)		Circuits	Dimensions(mm)	
	A	B		A	B
2P	2.54	7.12	14P	33.02	37.60
3P	5.08	9.66	15P	35.56	40.14
4P	7.62	12.20	16P	38.10	42.68
5P	10.16	14.74	17P	40.64	45.22
6P	12.70	17.28	18P	43.18	47.76
7P	15.24	19.82	19P	45.72	50.30
8P	17.78	22.36	20P	48.26	52.84
9P	20.32	24.90	21P	50.80	55.38
10P	22.86	27.44	22P	53.34	57.92
11P	25.40	29.98	23P	55.88	60.46
12P	27.94	32.52	24P	58.42	63.00
13P	30.48	35.06	25P	60.96	65.54

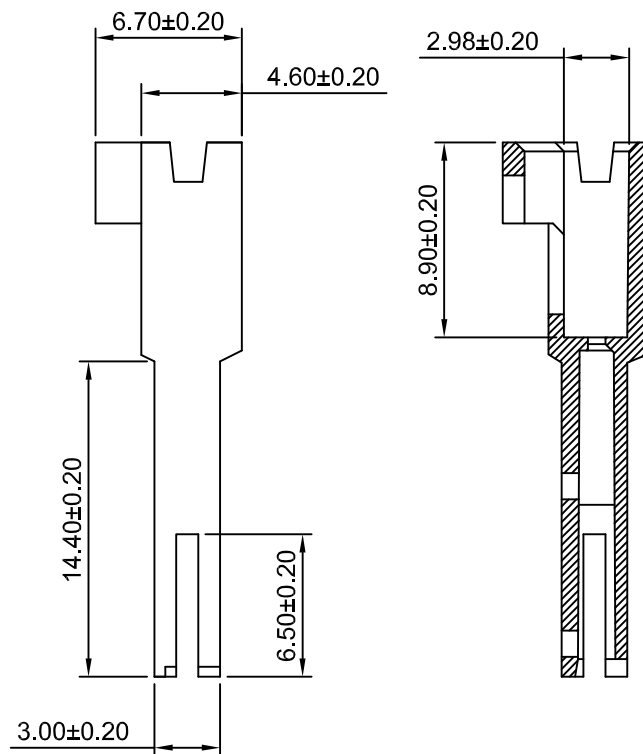
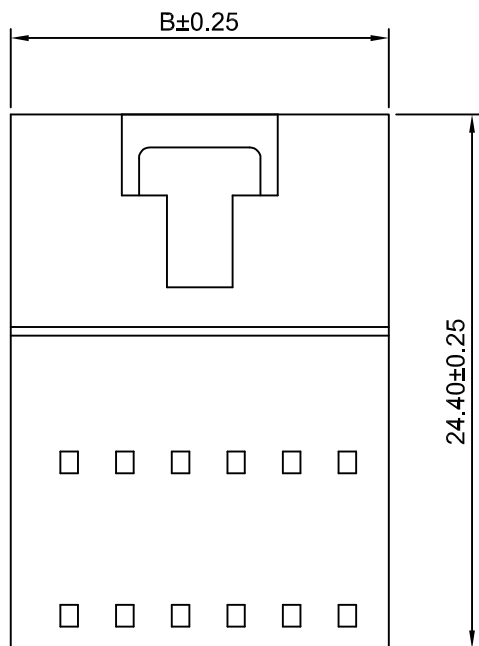

深圳市华德共创科技有限公司

SHENZHEN HUADE CO-CREATE TECHNOLOGY CO.,LTD

TEL : 0755-27129737 FAX : 0755-29940187

-TOLERANCES- UNLESS OTHERWISE SPECIFIED 公差参数表						TITLE: 2.54mm Pitch Housing 产品名称:			
X.X	±0.30	X.X°	±3°	APPD: 核准:	XIE	PART NO: 产品编号: HDGC2550HM-XP			
X.XX	±0.30	X.XX°	±2°	CHECK: 校对:	WANG	DATE	SCALE	UNIT	CODE NUMBER
X.XXX	±0.10	X.XXX°	±1°	DRAW: 绘图:	WANG	2012-12-10	3:1	mm	A008

修订 REV	标记 MARK	修改摘要 REVISION DESCRIPTION	签名 SIGNATURE	日期 DATE
AO		NEW RELEASE	WANG	2012-12-10

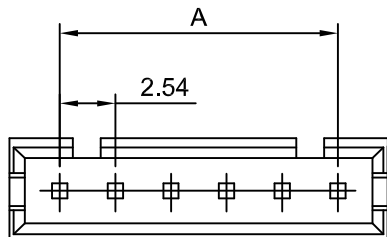

4P~25P

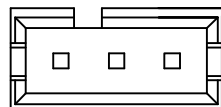

3P

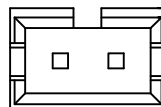

2P

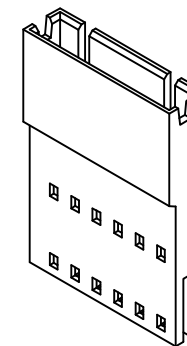

SPECIFICATIONS:

Current Rating: 3A AC,DC
Voltage Rating: 300V AC,DC
Temperature Range: -25°C ~ +85°C
Contact Resistance: 5mΩ Max
Insulation Resistance: 1000MΩ Min
Withstanding Voltage: 1100V AC/minute
Material: PBT30%GF,UL94V-0(Black)

Ordering Information & Dimensions

Circuits	Dimensions(mm)		Circuits	Dimensions(mm)	
	A	B		A	B
2P	2.54	7.12	14P	33.02	37.60
3P	5.08	9.66	15P	35.56	40.14
4P	7.62	12.20	16P	38.10	42.68
5P	10.16	14.74	17P	40.64	45.22
6P	12.70	17.28	18P	43.18	47.76
7P	15.24	19.82	19P	45.72	50.30
8P	17.78	22.36	20P	48.26	52.84
9P	20.32	24.90	21P	50.80	55.38
10P	22.86	27.44	22P	53.34	57.92
11P	25.40	29.98	23P	55.88	60.46
12P	27.94	32.52	24P	58.42	63.00
13P	30.48	35.06	25P	60.96	65.54

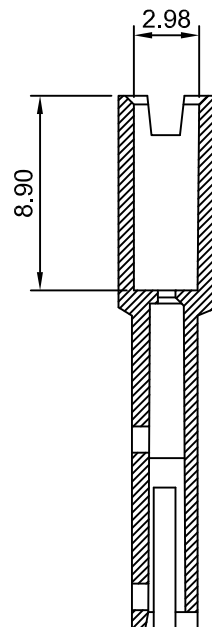
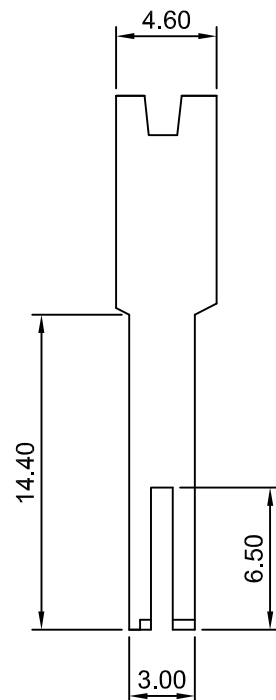
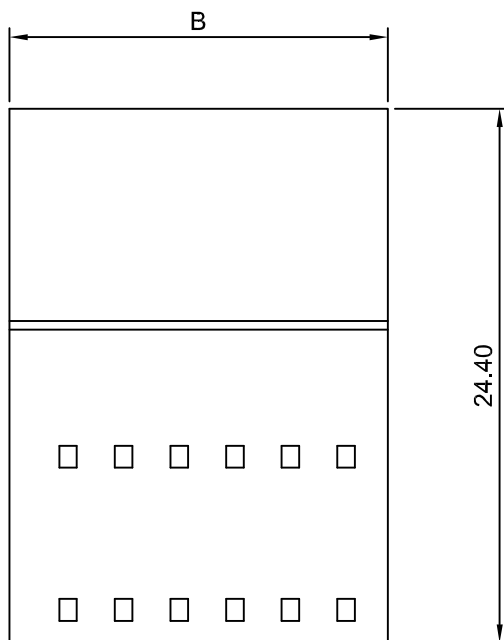

深圳市华德共创科技有限公司

SHENZHEN HUADE CO-CREATE TECHNOLOGY CO.,LTD

TEL : 0755-27129737 FAX : 0755-29940187

-TOLERANCES- UNLESS OTHERWISE SPECIFIED 公差参数表				 TITLE: 2.54mm Pitch Housing 产品名称: 2.54mm Pitch Housing	
X.X	±0.30	X.X°	±3°	APPD: 核准:	XIE
X.XX	±0.30	X.XX°	±2°	CHECK: 校对:	WANG
X.XXX	±0.10	X.XXX°	±1°	DRAW: 绘图:	WANG
PART NO: 产品编号:		HDGC2550HMA-XP			
DATE	SCALE	UNIT	CODE NUMBER		
2012-12-10	3:1	mm	A008		

修订 REV	标记 MARK	修改摘要 REVISION DESCRIPTION	签名 SIGNATURE	日期 DATE
AO		NEW RELEASE	WANG	2012-12-10

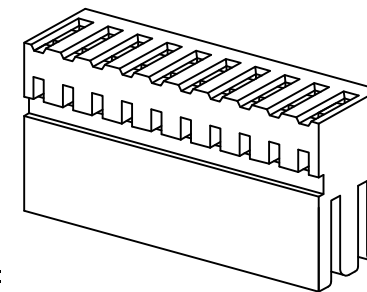
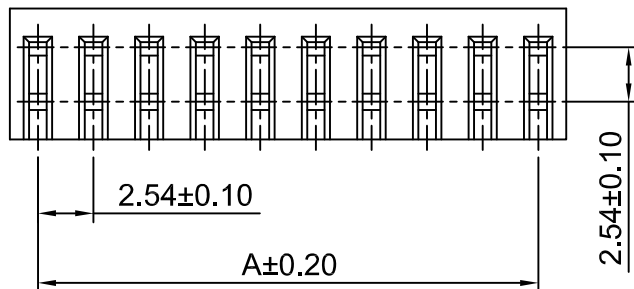

SPECIFICATIONS:

Current Rating: 3A AC,DC
Voltage Rating: 300V AC,DC
Temperature Range: -25°C ~ +85°C
Contact Resistance: 5mΩ Max
Insulation Resistance: 1000MΩ Min
Withstanding Voltage: 1100V AC/minute
Material: PBT30%GF,UL94V-0 (Black)

Ordering Information & Dimensions

Circuits	Dimensions(mm)		Circuits	Dimensions(mm)	
	A	B		A	B
2x2P	2.54	5.08	2x14P	33.02	35.56
2x3P	5.08	7.62	2x15P	35.56	38.10
2x4P	7.62	10.16	2x16P	38.10	40.64
2x5P	10.16	12.70	2x17P	40.64	43.18
2x6P	12.70	15.24	2x18P	43.18	45.72
2x7P	15.24	17.78	2x19P	45.72	48.26
2x8P	17.78	20.32	2x20P	48.26	50.80
2x9P	20.32	22.86	2x21P	50.80	53.34
2x10P	22.86	25.40	2x22P	53.34	55.88
2x11P	25.40	27.94	2x23P	55.88	58.42
2x12P	27.94	30.48	2x24P	58.42	60.96
2x13P	30.48	33.02	2x25P	60.96	63.50

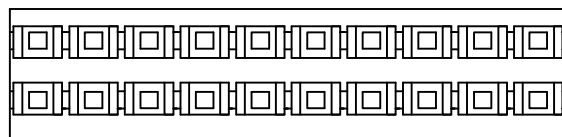
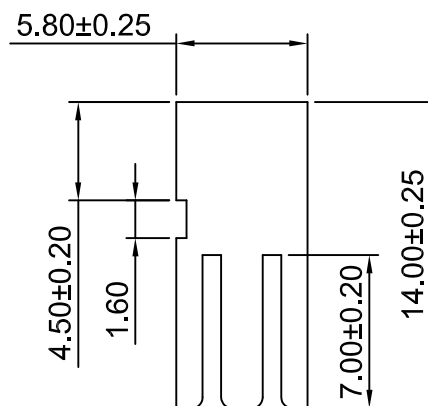
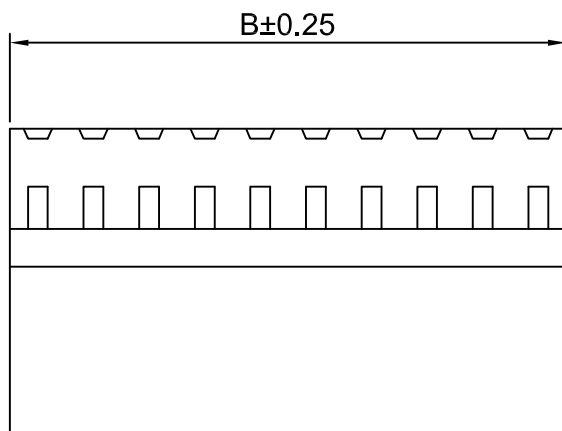

深圳市华德共创科技有限公司
SHENZHEN HUADE CO-CREATE TECHNOLOGY CO.,LTD
TEL : 0755-27129737 FAX : 0755-29940187

-TOLERANCES- UNLESS OTHERWISE SPECIFIED 公差参数表					TITLE: 2.54mm Pitch Housing 产品名称: 2.54mm Pitch Housing					
X.X	±0.30	X.X°	±3°	APPD: 核准:	XIE		PART NO: 产品编号: HDGC2550H-2xXP			
X.XX	±0.30	X.XX°	±2°	CHECK: 校对:	WANG		DATE	SCALE	UNIT	CODE NUMBER
X.XXX	±0.10	X.XXX°	±1°	DRAW: 绘图:	WANG		2012-12-10	4:1	mm	A008

修订 REV	标记 MARK	修改摘要 REVISION DESCRIPTION	签名 SIGNATURE	日期 DATE
AO		NEW RELEASE	WANG	2017-05-10

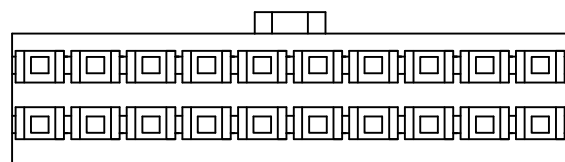
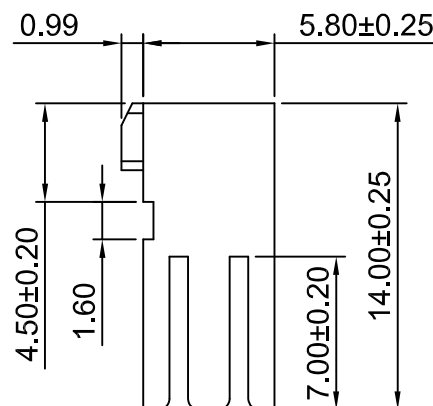
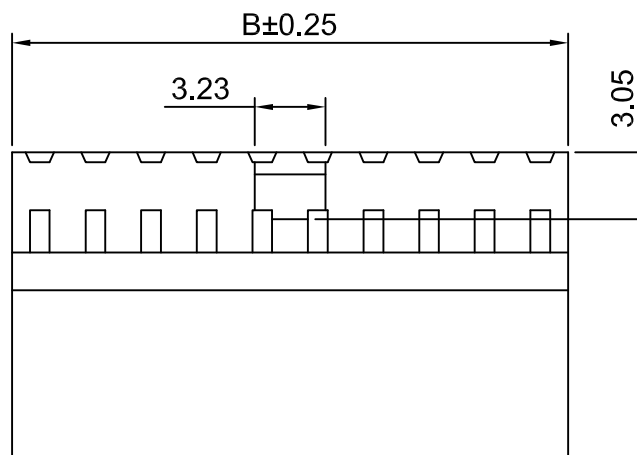
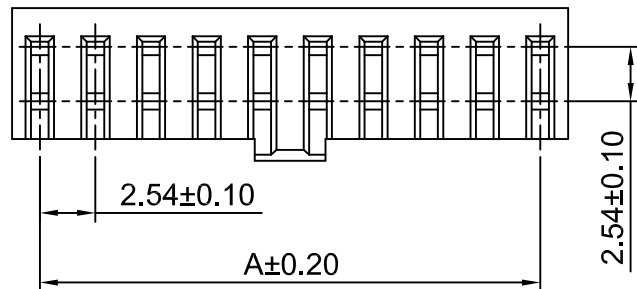

SPECIFICATIONS:

Current Rating: 3A AC,DC
Voltage Rating: 300V AC,DC
Temperature Range: -25°C ~ +85°C
Contact Resistance: 5mΩ Max
Insulation Resistance: 1000MΩ Min
Withstanding Voltage: 1100V AC/minute
Material: PBT+30%GF,UL94V-0 (Black)

Ordering Information & Dimensions

Circuits	Dimensions(mm)		Circuits	Dimensions(mm)	
	A	B		A	B
2x2P	2.54	5.08	2x14P	33.02	35.56
2x3P	5.08	7.62	2x15P	35.56	38.10
2x4P	7.62	10.16	2x16P	38.10	40.64
2x5P	10.16	12.70	2x17P	40.64	43.18
2x6P	12.70	15.24	2x18P	43.18	45.72
2x7P	15.24	17.78	2x19P	45.72	48.26
2x8P	17.78	20.32	2x20P	48.26	50.80
2x9P	20.32	22.86	2x21P	50.80	53.34
2x10P	22.86	25.40	2x22P	53.34	55.88
2x11P	25.40	27.94	2x23P	55.88	58.42
2x12P	27.94	30.48	2x24P	58.42	60.96
2x13P	30.48	33.02	2x25P	60.96	63.50



深圳市华德共创科技有限公司

SHENZHEN HUADE CO-CREATE TECHNOLOGY CO.,LTD

TEL : 0755-27129737 FAX : 0755-29940187

-TOLERANCES- UNLESS OTHERWISE SPECIFIED 公差参数表						TITLE: 2.54mm Pitch Housing 产品名称:			
X.X	±0.30	X.X°	±3°	APPD: 核准:	XIE	PART NO: 产品编号: HDGC2550H-N-2xXP			
X.XX	±0.30	X.XX°	±2°	CHECK: 校对:	WANG	DATE	SCALE	UNIT	CODE NUMBER
X.XXX	±0.10	X.XXX°	±1°	DRAW: 绘图:	WANG	2017-05-10	4:1	mm	A008

修订 REV	标记 MARK	修改摘要 REVISION DESCRIPTION	签名 SIGNATURE	日期 DATE
AO		NEW RELEASE	WANG	2012-12-10

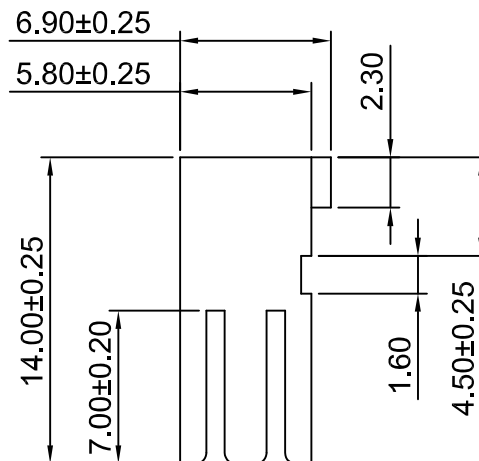
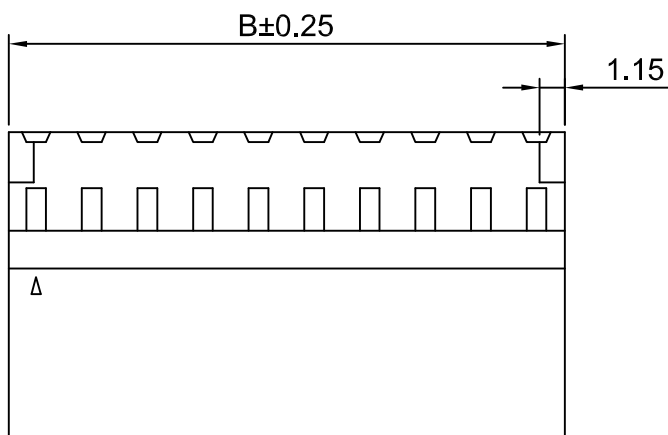
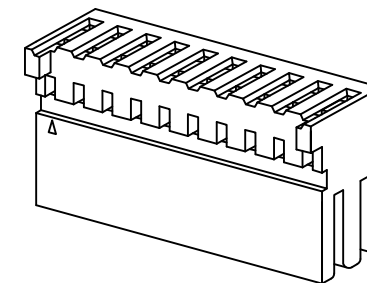
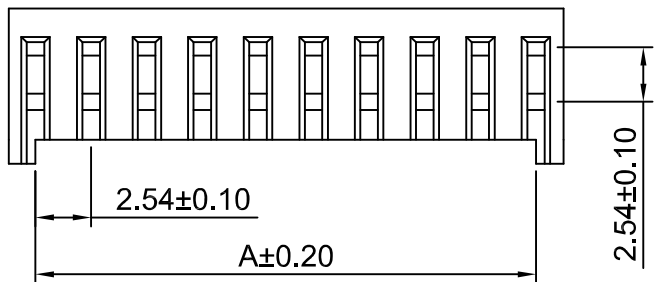

SPECIFICATIONS:

Current Rating: 3A AC,DC
Voltage Rating: 300V AC,DC
Temperature Range: -25°C ~ +85°C
Contact Resistance: 5mΩ Max
Insulation Resistance: 1000MΩ Min
Withstanding Voltage: 1100V AC/minute
Material: PBT30%GF,UL94V-0(Black)

Ordering Information & Dimensions

Circuits	Dimensions(mm)		Circuits	Dimensions(mm)	
	A	B		A	B
2x2P	2.54	5.08	2x14P	33.02	35.56
2x3P	5.08	7.62	2x15P	35.56	38.10
2x4P	7.62	10.16	2x16P	38.10	40.64
2x5P	10.16	12.70	2x17P	40.64	43.18
2x6P	12.70	15.24	2x18P	43.18	45.72
2x7P	15.24	17.78	2x19P	45.72	48.26
2x8P	17.78	20.32	2x20P	48.26	50.80
2x9P	20.32	22.86	2x21P	50.80	53.34
2x10P	22.86	25.40	2x22P	53.34	55.88
2x11P	25.40	27.94	2x23P	55.88	58.42
2x12P	27.94	30.48	2x24P	58.42	60.96
2x13P	30.48	33.02	2x25P	60.96	63.50

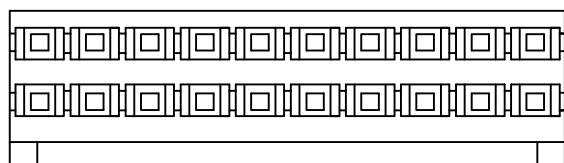

HDGC 深圳市华德共创科技有限公司
SHENZHEN HUADE CO-CREATE TECHNOLOGY CO.,LTD
TEL : 0755-27129737 FAX : 0755-29940187

-TOLERANCES- UNLESS OTHERWISE SPECIFIED 公差参数表						TITLE: 2.54mm Pitch Housing 产品名称: 2.54mm Pitch Housing			
X.X	±0.30	X.X°	±3°	APPD: 核准:	XIE	PART NO: 产品编号: HDGC2550HA-2xXP			
X.XX	±0.30	X.XX°	±2°	CHECK: 校对:	WANG	DATE	SCALE	UNIT	CODE NUMBER
X.XXX	±0.10	X.XXX°	±1°	DRAW: 绘图:	WANG	2012-12-10	3:1	mm	A008

修订 REV	标记 MARK	修改摘要 REVISION DESCRIPTION	签名 SIGNATURE	日期 DATE
AO		NEW RELEASE	WANG	2017-12-10

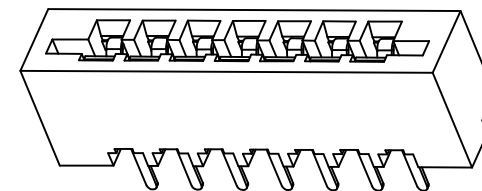
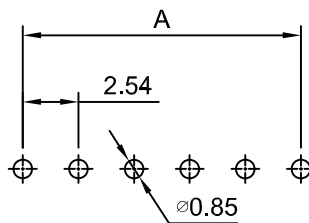
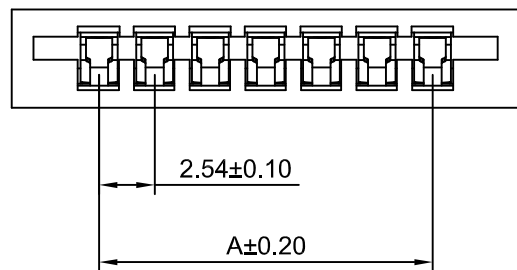

SPECIFICATIONS:

Current Rating: 1A AC,DC
Voltage Rating: 250V AC,DC
Temperature Range: -25°C ~ +85°C
Contact Resistance: 30mΩ Max
Insulation Resistance: 1000MΩ Min
Withstanding Voltage: 1000V AC/minute
Pin Material: Phosphor Bronze/Tin over Nickel
Material: PBT, UL94V-0(Black)

Ordering Information & Dimensions

Circuits	Dimensions(mm)			Circuits	Dimensions(mm)		
	A	B	C		A	B	C
3P	5.08	13.04	10.16	15P	35.56	43.52	40.64
4P	7.62	15.58	12.70	16P	38.10	46.06	43.18
5P	10.16	18.12	15.24	17P	40.64	48.60	45.72
6P	12.70	20.66	17.78	18P	43.18	51.14	48.26
7P	15.24	23.20	20.32	19P	45.72	53.68	50.80
8P	17.78	25.74	22.86	20P	48.26	56.22	53.34
9P	20.32	28.28	25.40	21P	50.80	58.76	55.88
10P	22.86	30.82	27.94	22P	53.34	61.30	58.42
11P	25.40	33.36	30.48	23P	55.88	63.84	60.96
12P	27.94	35.90	33.02	24P	58.42	66.38	63.50
13P	30.48	38.44	35.56	25P	60.96	68.92	66.04
14P	33.02	40.98	38.10				

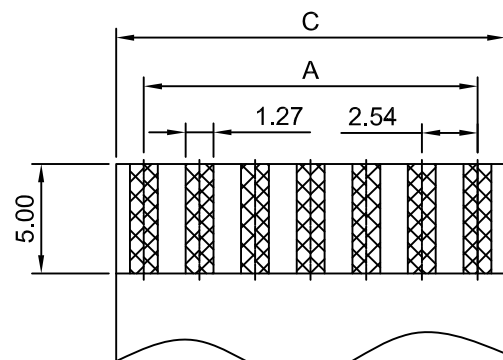
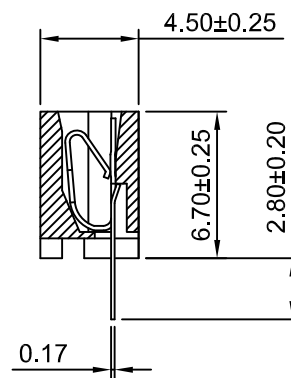
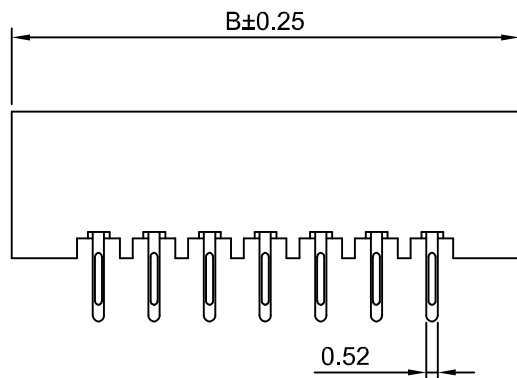

FPC/FFC T=0.30



深圳市华德共创科技有限公司

SHENZHEN HUADE CO-CREATE TECHNOLOGY CO.,LTD

TEL : 0755-27129737 FAX : 0755-29940187

-TOLERANCES- UNLESS OTHERWISE SPECIFIED 公差参数表				 TITLE: 2.54mm Pitch 产品名称: 180° Wafer					
X.X	±0.30	X.X°	±3°	APPD: 核准:	XIE	PART NO: 产品编号: HDGC2550WVF-XP			
X.XX	±0.30	X.XX°	±2°	CHECK: 校对:	WANG	DATE	SCALE	UNIT	CODE NUMBER
X.XXX	±0.10	X.XXX°	±1°	DRAW: 绘图:	WANG	2017-12-10	3:1	mm	A008

修订 REV	标记 MARK	修改摘要 REVISION DESCRIPTION	签名 SIGNATURE	日期 DATE
AO		NEW RELEASE	WANG	2017-12-10

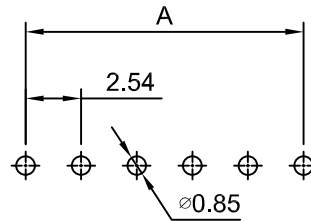
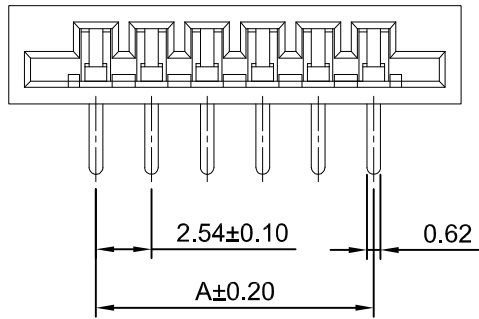

P.C.B LAYOUT

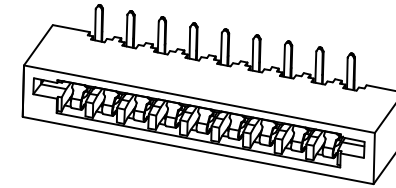

SPECIFICATIONS:

Current Rating: 1A AC,DC
Voltage Rating: 250V AC,DC
Temperature Range: -25°C ~ +85°C
Contact Resistance: 30mΩ Max
Insulation Resistance: 1000MΩ Min
Withstanding Voltage: 1000V AC/minute
Pin Material: Phosphor Bronze/Tin over Nickel
Material: PBT, UL94V-0(Black)

Ordering Information & Dimensions

Circuits	Dimensions(mm)			Circuits	Dimensions(mm)		
	A	B	C		A	B	C
3P	5.08	13.04	10.16	15P	35.56	43.52	40.64
4P	7.62	15.58	12.70	16P	38.10	46.06	43.18
5P	10.16	18.12	15.24	17P	40.64	48.60	45.72
6P	12.70	20.66	17.78	18P	43.18	51.14	48.26
7P	15.24	23.20	20.32	19P	45.72	53.68	50.80
8P	17.78	25.74	22.86	20P	48.26	56.22	53.34
9P	20.32	28.28	25.40	21P	50.80	58.76	55.88
10P	22.86	30.82	27.94	22P	53.34	61.30	58.42
11P	25.40	33.36	30.48	23P	55.88	63.84	60.96
12P	27.94	35.90	33.02	24P	58.42	66.38	63.50
13P	30.48	38.44	35.56	25P	60.96	68.92	66.04
14P	33.02	40.98	38.10				

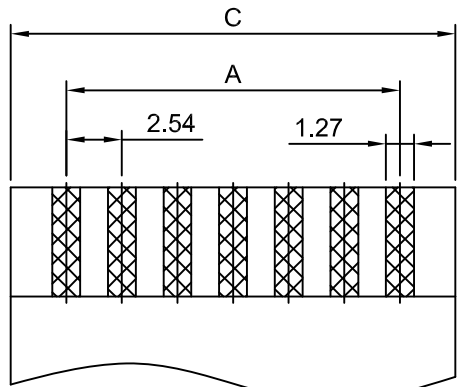
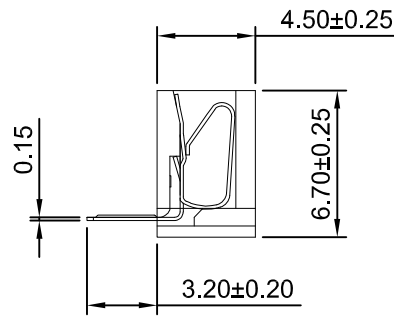
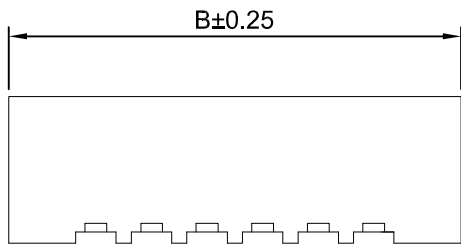

FPC/FFC T=0.30



深圳市华德共创科技有限公司

SHENZHEN HUADE CO-CREATE TECHNOLOGY CO.,LTD

TEL : 0755-27129737 FAX : 0755-29940187

-TOLERANCES- UNLESS OTHERWISE SPECIFIED 公差参数表						TITLE: 2.54mm Pitch 产品名称: 90° Wafer			
X.X	±0.30	X.X°	±3°	APPD: 核准:	XIE	PART NO: 产品编号: HDGC2550WRF-XP			
X.XX	±0.30	X.XX°	±2°	CHECK: 校对:	WANG	DATE	SCALE	UNIT	CODE NUMBER
X.XXX	±0.10	X.XXX°	±1°	DRAW: 绘图:	WANG	2017-12-10	3:1	mm	A008

修订 REV	标记 MARK	修改摘要 REVISION DESCRIPTION	签名 SIGNATURE	日期 DATE
AO		NEW RELEASE	WANG	2017-12-10

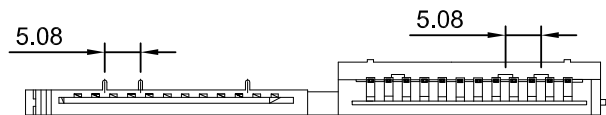

12P

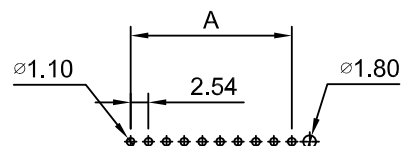

P.C.B LAYOUT
Type 1

Ordering Information:
HDGC2550WVD-F-XP - **
1 2

- 1.Part No.
2.Style:
(Blank): Type 1
2: Type 2
3: Type 3

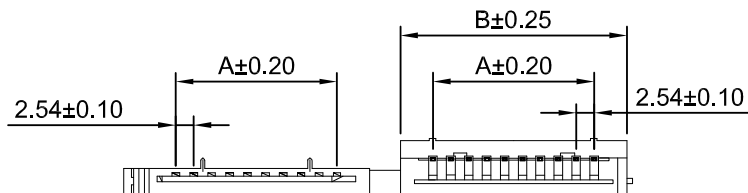
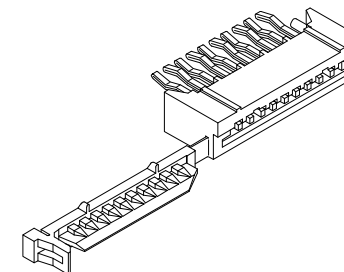

8P~11P,13P,14P

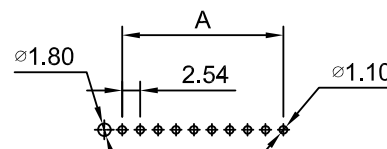

P.C.B LAYOUT
Type 2

SPECIFICATIONS:
Current Rating: 1A AC,DC
Voltage Rating: 250V AC,DC
Temperature Range: -25°C ~ +85°C
Contact Resistance: 30mΩ Max
Insulation Resistance: 1000MΩ Min
Withstanding Voltage: 1000V AC/minute
Pin Material: Phosphor Bronze/Tin over Nickel
Material: Nylon66, UL94V-0(White)

Ordering Information & Dimensions

Circuits	Dimensions(mm)			Circuits	Dimensions(mm)		
	A	B	C		A	B	C
8P	17.78	27.05	10.16	12P	27.94	37.21	20.32
9P	20.32	29.59	12.70	13P	30.48	39.76	22.86
10P	22.86	32.13	15.24	14P	33.02	42.29	25.40
11P	25.40	34.67	17.78				

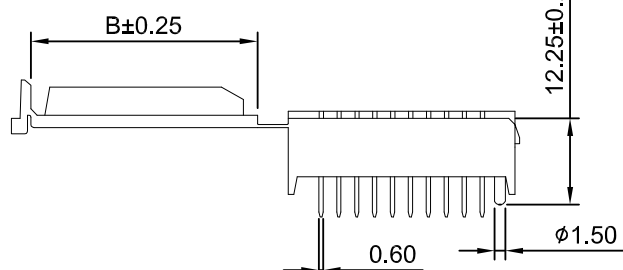

Type 1

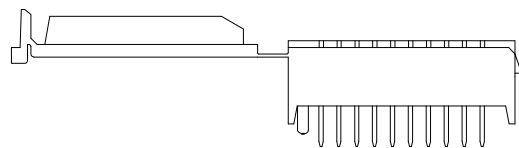
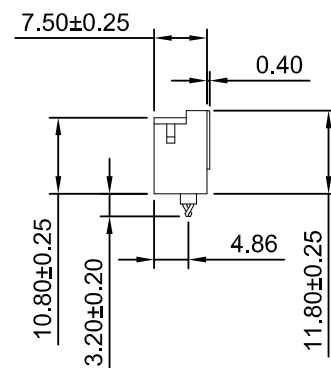

Type 2

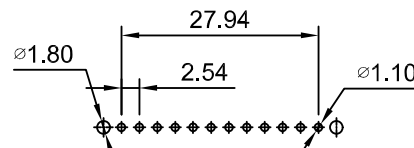

P.C.B LAYOUT
Type 3

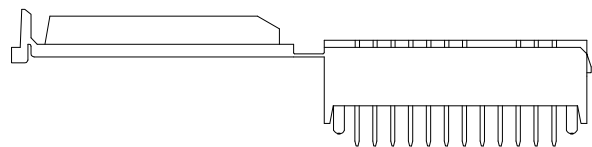

Type 3
(12P)



深圳市华德共创科技有限公司

SHENZHEN HUADE CO-CREATE TECHNOLOGY CO.,LTD

TEL : 0755-27129737 FAX : 0755-29940187

-TOLERANCES- UNLESS OTHERWISE SPECIFIED 公差参数表				TITLE: 产品名称: 2.54mm Pitch 180° Wafer	
X.X	±0.30	X.X°	±3°	APPD: 核准:	XIE
X.XX	±0.30	X.XX°	±2°	CHECK: 校对:	WANG
X.XXX	±0.10	X.XXX°	±1°	DRAW: 绘图:	WANG
PART NO: 产品编号:		HDGC2550WVD-F-XP			
DATE	SCALE	UNIT	CODE NUMBER		
2017-12-10	1:1	mm	A008		

修订 REV	标记 MARK	修改摘要 REVISION DESCRIPTION	签名 SIGNATURE	日期 DATE
AO		NEW RELEASE	WANG	2017-12-10

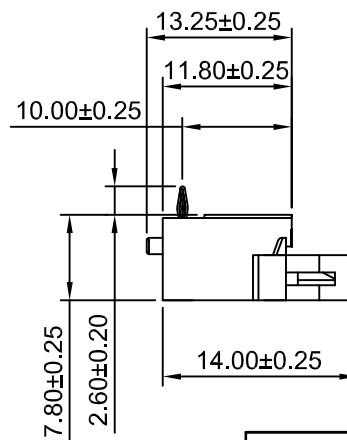
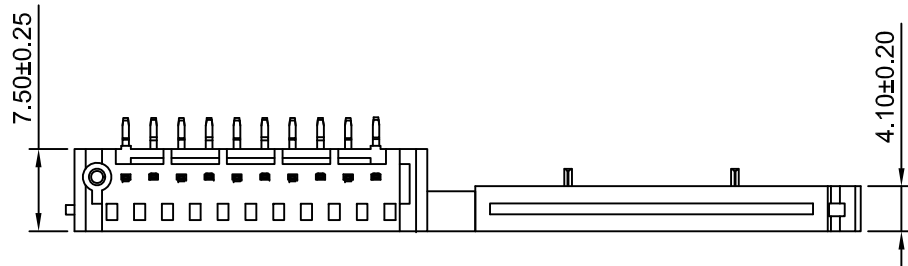
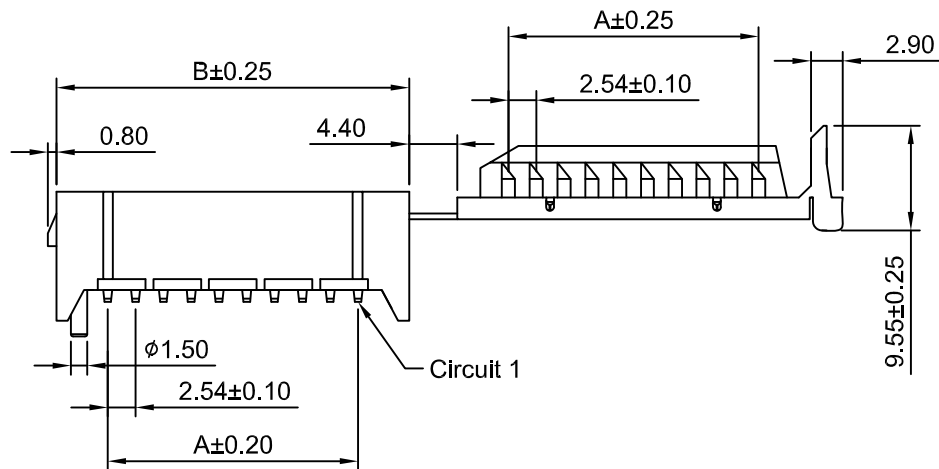

SPECIFICATIONS:

Current Rating: 1A AC,DC
Voltage Rating: 250V AC,DC
Temperature Range: -25°C ~ +85°C
Contact Resistance: 30mΩ Max
Insulation Resistance: 1000MΩ Min
Withstanding Voltage: 1000V AC/minute
Pin Material: Phosphor Bronze/Tin over Nickel
Material: Nylon66, UL94V-0(White)

Ordering Information & Dimensions

Circuits	Dimensions(mm)		Circuits	Dimensions(mm)	
	A	B		A	B
1P	----	9.34	14P	33.02	42.36
2P	2.54	11.88	15P	35.56	44.90
3P	5.08	14.42	16P	38.10	47.44
4P	7.62	16.96	17P	40.64	49.98
5P	10.16	19.50	18P	43.18	52.52
6P	12.70	22.04	19P	45.72	55.06
7P	15.24	24.58	20P	48.26	57.60
8P	17.78	27.12	21P	50.80	60.14
9P	20.32	29.66	22P	53.34	62.68
10P	22.86	32.20	23P	55.88	65.22
11P	25.40	34.74	24P	58.42	67.76
12P	27.94	37.28	25P	60.96	70.30
13P	30.48	39.82			



深圳市华德共创科技有限公司

SHENZHEN HUADE CO-CREATE TECHNOLOGY CO.,LTD

TEL : 0755-27129737 FAX : 0755-29940187

-TOLERANCES- UNLESS OTHERWISE SPECIFIED 公差参数表						TITLE: 2.54mm Pitch 产品名称: 90° Wafer			
X.X	±0.30	X.X°	±3°	APPD: 核准:	XIE	PART NO: 产品编号: HDGC2550WRFD-XP			
X.XX	±0.30	X.XX°	±2°	CHECK: 校对:	WANG	DATE	SCALE	UNIT	CODE NUMBER
X.XXX	±0.10	X.XXX°	±1°	DRAW: 绘图:	WANG	2017-12-10	1.5:1	mm	A008

修订 REV	标记 MARK	修改摘要 REVISION DESCRIPTION	签名 SIGNATURE	日期 DATE
AO		NEW RELEASE	WANG	2017-12-10

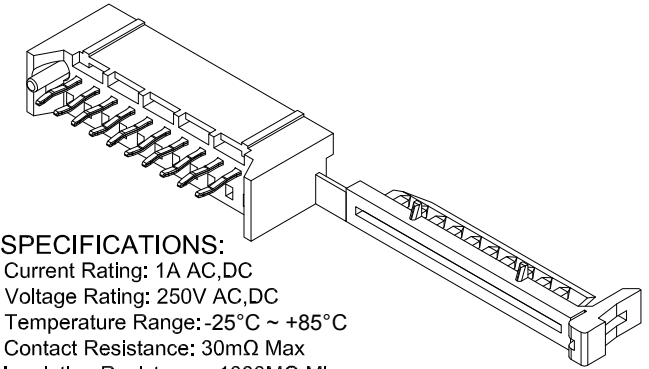
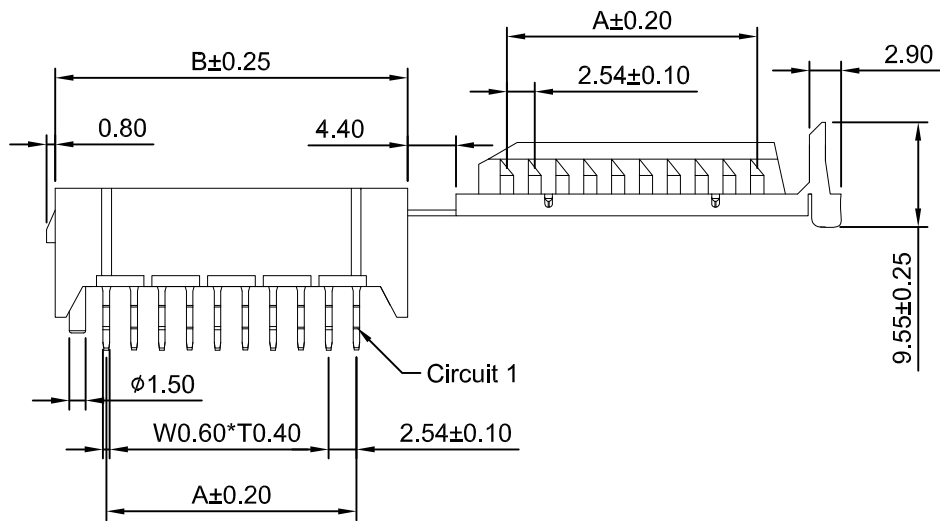

SPECIFICATIONS:

Current Rating: 1A AC,DC
Voltage Rating: 250V AC,DC
Temperature Range: -25°C ~ +85°C
Contact Resistance: 30mΩ Max
Insulation Resistance: 1000MΩ Min
Withstanding Voltage: 1000V AC/minute
Pin Material: Phosphor Bronze/Tin over Nickel
Material: Nylon66, UL94V-0(White)

Ordering Information & Dimensions

Circuits	Dimensions(mm)		Circuits	Dimensions(mm)	
	A	B		A	B
1P	----	9.34	14P	33.02	42.36
2P	2.54	11.88	15P	35.56	44.90
3P	5.08	14.42	16P	38.10	47.44
4P	7.62	16.96	17P	40.64	49.98
5P	10.16	19.50	18P	43.18	52.52
6P	12.70	22.04	19P	45.72	55.06
7P	15.24	24.58	20P	48.26	57.60
8P	17.78	27.12	21P	50.80	60.14
9P	20.32	29.66	22P	53.34	62.68
10P	22.86	32.20	23P	55.88	65.22
11P	25.40	34.74	24P	58.42	67.76
12P	27.94	37.28	25P	60.96	70.30
13P	30.48	39.82			

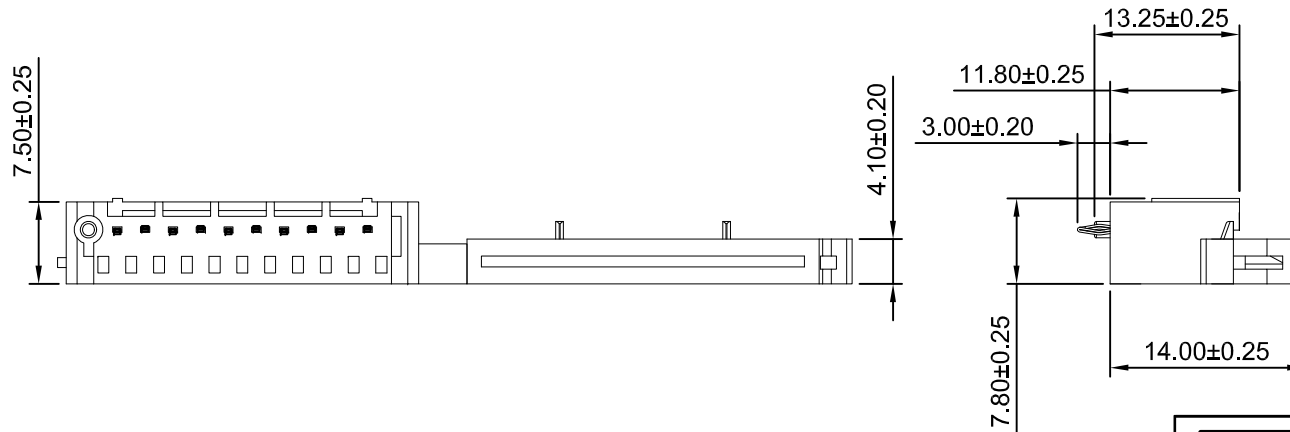

HDGC 深圳市华德共创科技有限公司
SHENZHEN HUADE CO-CREATE TECHNOLOGY CO.,LTD
TEL : 0755-27129737 FAX : 0755-29940187

-TOLERANCES- UNLESS OTHERWISE SPECIFIED 公差参数表				TITLE: 产品名称: 2.54mm Pitch 180° Wafer	
X.X	±0.30	X.X°	±3°	APPD: 核准:	XIE
X.XX	±0.30	X.XX°	±2°	CHECK: 校对:	WANG
X.XXX	±0.10	X.XXX°	±1°	DRAW: 绘图:	WANG
PART NO: 产品编号:			HDGC2550WVFD-XP		
DATE	SCALE	UNIT	CODE NUMBER		
2017-12-10	1.5:1	mm	A008		

修订 REV	标记 MARK	修改摘要 REVISION DESCRIPTION	签名 SIGNATURE	日期 DATE
AO		NEW RELEASE	WANG	2017-12-10

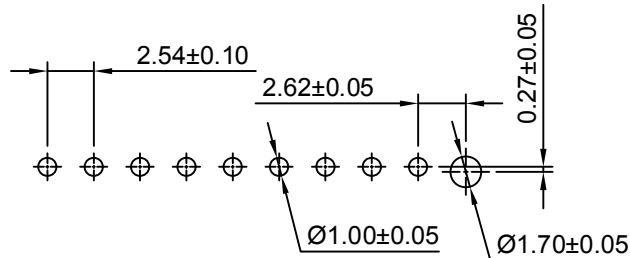
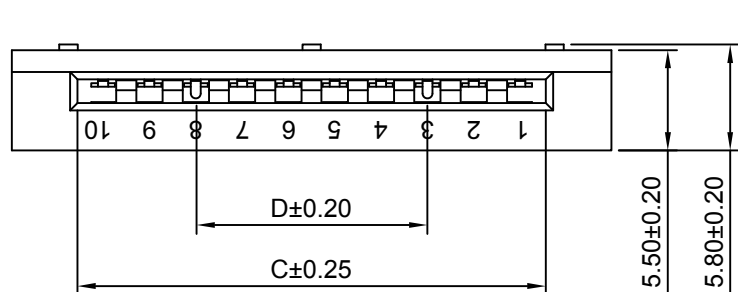

PCB LAYOUT

SPECIFICATIONS:

Current Rating: 1A AC,DC
Voltage Rating: 250V AC,DC
Temperature Range: -25°C ~ +85°C
Contact Resistance: 30mΩ Max
Insulation Resistance: 1000MΩ Min
Withstanding Voltage: 1000V AC/minute
Pin Material: Phosphor Bronze/Tin over Nickel
Material: PBT, UL94V-0(Blue)

Ordering Information & Dimensions

Circuits	Dimensions(mm)			
	A	B	C	D
8P	17.78	30.34	23.12	10.16
9P	20.32	32.88	25.66	12.70
10P	22.86	35.42	28.20	15.24
11P	25.40	37.96	30.74	17.78
12P	27.94	40.50	33.28	20.32
13P	30.48	43.04	35.82	22.86

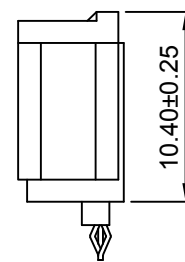
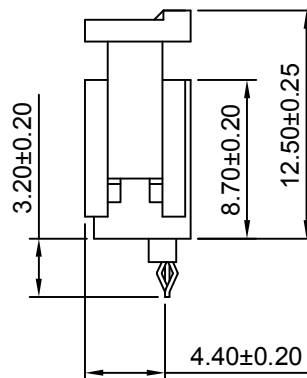
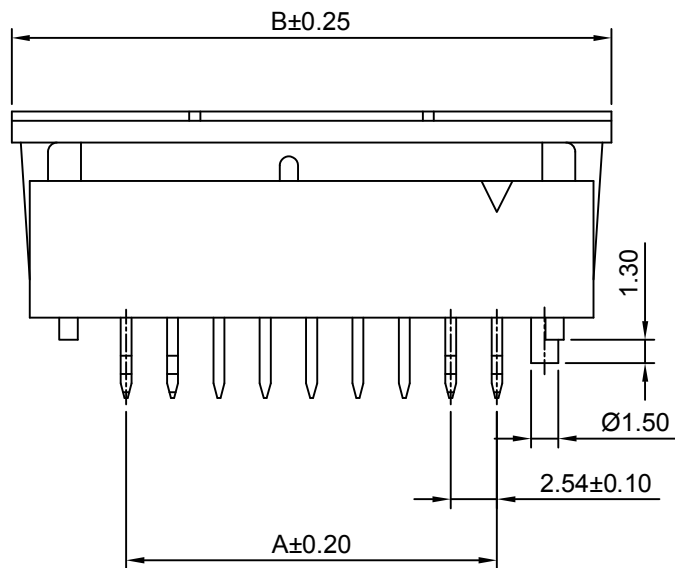

深圳市华德共创科技有限公司

SHENZHEN HUADE CO-CREATE TECHNOLOGY CO.,LTD

TEL : 0755-27129737 FAX : 0755-29940187

-TOLERANCES- UNLESS OTHERWISE SPECIFIED 公差参数表				TITLE: 产品名称: 2.54mm Pitch 180° Wafer	
X.X	±0.30	X.X°	±3°	APPD: 核准:	XIE
X.XX	±0.30	X.XX°	±2°	CHECK: 校对:	WANG
X.XXX	±0.10	X.XXX°	±1°	DRAW: 绘图:	WANG
PART NO: 产品编号:			HDGC2550WFC-F-XP		
DATE		SCALE	UNIT	CODE NUMBER	
2017-12-10		2.5:1	mm	A008	